



INSPIRING PROFILES

ORAC<sup>®</sup>  
DECOR

*'The making of'*

INSPIRING PROFILES

ORAC®  
DECOR

## The script

NL

Welkom in de droomwereld van ORAC DECOR®.

ORAC DECOR® is dé referentie voor hoogkwalitatieve en architecturale profielen. Een complete collectie gemaakt door en voor gepassioneerde vaklui. Stielmannen met een logische geest die houden van innovatieve en makkelijk te installeren kwaliteitsproducten. Van plinten en indirecte verlichtingsprofielen over multifunctionele profielen tot en met kroonlijsten met karakter. Eigentijdse kwaliteitsoplossingen, functioneel én decoratief. En op maat van elk project. Met ORAC DECOR® heeft u alle troeven in handen om uw project in uitstekende banen te leiden.

U bent de regisseur van uw eigen film of project. Wij bieden u al de mogelijke noodzakelijke accessoires/rekwisieten om van uw project een pronkstuk te maken.

Samen vormen we een ijzersterk team, klaar voor de eerste Oscar!

FR

Bienvenue dans le monde féérique d'ORAC DECOR®.

ORAC DECOR® est la référence en matière de profilés architecturaux haut de gamme. Une collection complète, faite par et pour des spécialistes passionnés. Des stylistes amoureux des produits novateurs et faciles à installer, proposent des plinthes, des profilés d'éclairage indirect, des profilés multifonctions, en passant par des corniches de grand caractère. Des solutions modernes, de haute qualité, fonctionnelles, décoratives spécifique à chaque projet : Avec ORAC DECOR®, vous avez tous les atouts en main pour mettre votre projet sur les rails.

Vous êtes le réalisateur de votre propre film ou projet. Nous vous fournissons tous les accessoires et outils pour en faire une perle parmi les perles.

Ensemble, nous formons une équipe solide comme un roc, prête pour son premier Oscar!

EN

Welcome to the dream world of ORAC DECOR®.

ORAC DECOR® sets the standard for high quality architectural mouldings. Our complete collection is made by and for passionate professionals, craftsmen with logical minds who appreciate high quality products that are innovative and easy to install. From skirting boards and indirect lighting profiles to multifunctional profiles and cornices with character, our high quality contemporary solutions are functional, decorative and tailored to each project. With ORAC DECOR®, you have nothing but trumps in your hand to bring your project to an outstanding conclusion.

You are the director of your own film or project. We can offer you every possible accessory or prop that you need to turn your project into a showpiece.

Together, we make an unbeatable team, ready for the first Oscar!

DE

Willkommen in der Traumwelt von ORAC DECOR®.

ORAC DECOR® ist der führende Anbieter von hochqualitativen Zierprofilen. Eine umfassende Kollektion – hergestellt von passionierten Fachleuten für passionierte Fachleute. Kenner mit logischem Sachverstand, die innovative und mühelos installierbare Qualitätsprodukte schätzen. Von Sockelleisten und Lichtleisten für indirekte Beleuchtung über multifunktionale Leisten bis hin zu stilvollen Eckleisten. Zeitgemäße Qualitätslösungen, funktionell und dekorativ. Und individuell abgestimmt auf jedes Projekt. Mit ORAC DECOR® haben Sie alle Trümpfe in der Hand, die den Erfolg Ihres Projekts gewährleisten.

Sie sind der Regisseur Ihres eigenen Films oder Projekts. Wir bieten Ihnen alle erdenklichen und benötigten Accessoires, damit Ihr Projekt ein Meisterwerk wird.

Gemeinsam sind wir ein bärenstarkes Team - bereit für den ersten Oscar!

ES

Bienvenido al mundo elegante de ORAC DECOR®.

ORAC DECOR® es un referente en el mundo de los perfiles arquitectónicos orientados a la decoración. Toda una gama realizada por y para ayudar a crear valor añadido en los proyectos; tanto de casas particulares, como restaurantes, hoteles, etc. Resaltar la innovación, calidad y fácil instalación de nuestros productos; desde zócalos, molduras, cornisas, marcos de puertas, perfiles con iluminación indirecta y la novedad de nuevos modelos multifuncionales y todo ello resistente al agua, con posibilidad de instalarse en el exterior y listas para ser pintadas. Proponemos soluciones actuales, de calidad, funcionales y decorativas. Con ORAC DECOR® puedes crear tu mundo según tus gustos y necesidades con total garantía de éxito.

Puedes ser el decorador de su propia película en tu mundo. Nosotros ponemos a tu disposición todos los accesorios/utilería necesarios para que el resultado final cumpla con tus expectativas. Juntos formamos un buen equipo y podemos conseguir el primer 'Oscar'.



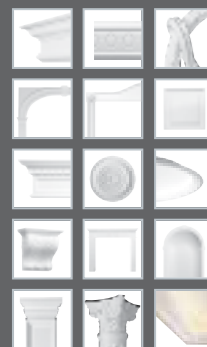

**PUROTOUCH®**

- Een kwalitatieve polyurethaan van hoge densiteit
- Un polyuréthane moulé de haute densité
- A moulded quality high-density polyurethane
- Ein hochwertiges, hochdichtes Polyurethanschaum
- Poliuretano de alta calidad y de elevada densidad

**DUROPOLYMER®**

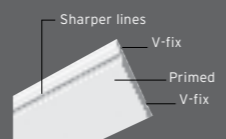
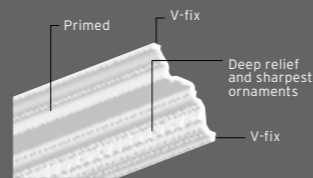

ref. Luzzus **LXX**



**DUROPOLYMER®**

- Geëxtrudeerde en impactbestendige polystyreenmix van hoge densiteit
- Un polymère extrudé résistant aux impacts à base d'un mélange de polystyrènes haute densité
- An extruded and impact-resistant polymer based on a high-density polystyrene
- Extrudierter und schlagbeständiger, hochdichter Polystyrolmix
- Polímero fabricados por extrusión, resistente a impactos fuertes a base de una mezcla de poliestireno de alta densidad

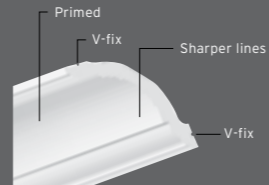

ref. Axxent **AXX**



**DUROFOAM®**

- Geëxtrudeerde lichtgewichtpolymeer op basis van een polystyreenmix van medium densiteit
- Un polymère léger extrudé à base d'un mélange de polystyrènes de densité moyenne
- An extruded lightweight polymer based on a medium-density polystyrene blend
- Extrudiertes leichtes Polymer auf der Grundlage einer Polystyrolmischungmittlerer Dichte
- Polímero extrusionado de peso ligero a base de una mezcla de poliestireno de densidad media

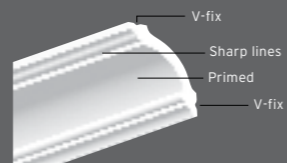

ref. Basixx **BXX**



DX121-2300 P72



PX103 P66



PX120 P66



PX114 P66



SX156 P69



DX119-2300 P72



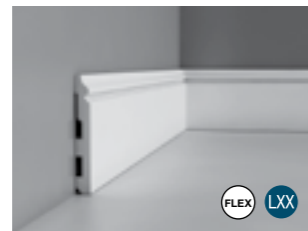
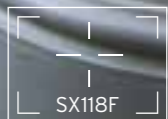
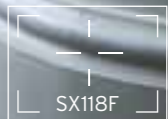

SX118F



P69

*Metiendō Vivendum - Louvain*



SX118

SX104

also starring in this collection ★



SX118



P69



PX103



P66



D62



P89



PX117



P66



PX113



P50

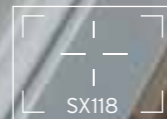
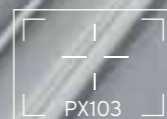
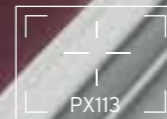
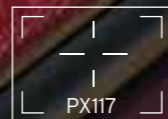



R40

P86

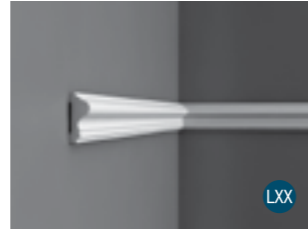

P8020/P8020F

P60



P8040

P62



SX118

P69

Bucharest

Sofitel  
Brussels



C322

P43



C332

P45



C333

P45

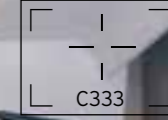
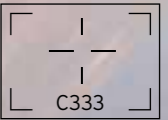
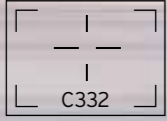
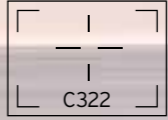

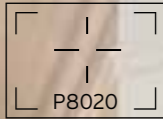
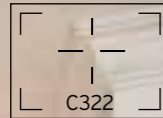

C322

P43



P8020

P60

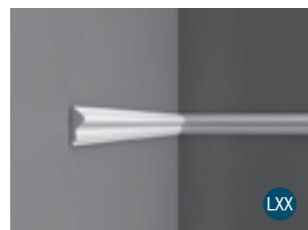

P8030

P60



SX118

P69

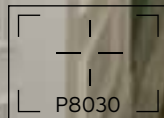
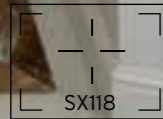

R38

P89



also starring in this collection ★



C422

P50



also starring in this collection ★

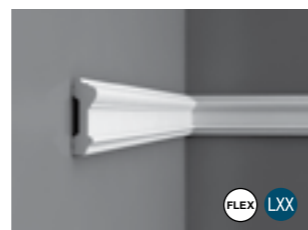

P9010/P9010F

FLEX

LXX

P61



PX120

AXX

P66



also starring in this collection ★



SX156

LXX

P69



PX103

AXX

P66

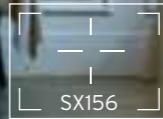
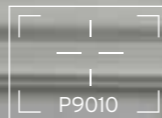
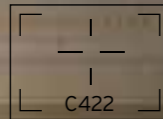
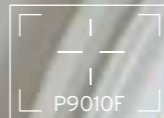

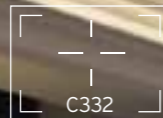

C217

LXX

P45



C321

★ also starring in this collection



C332

LXX

P45

★ also starring in this collection  
designed by Jaques Vergracht

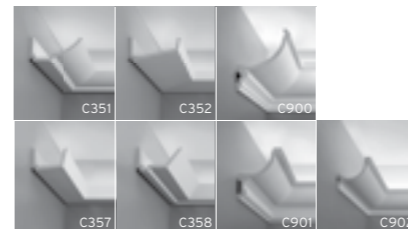

C351

C352

C900

C357

C358

C901

C902

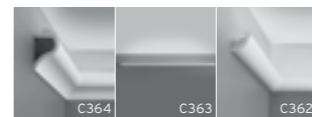

C364

C363

C362

also starring in this collection ★  
designed by Pierre Daems

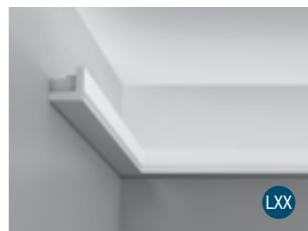

C361

LXX

P58/101



DX157-2300

AXX

P67/68

*Lobby Amsterdam*

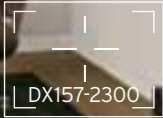

DX157-2300



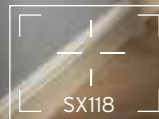
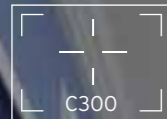

St-Petersburg

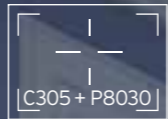
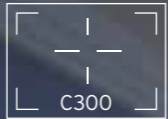
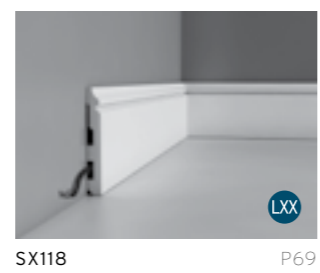
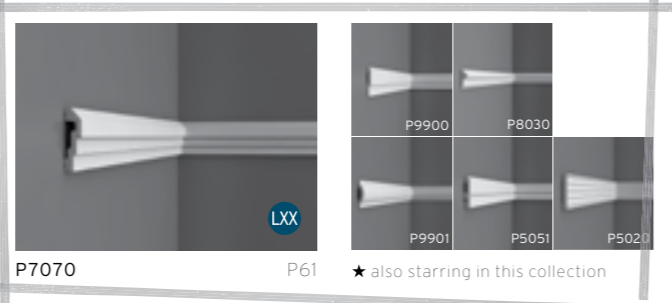
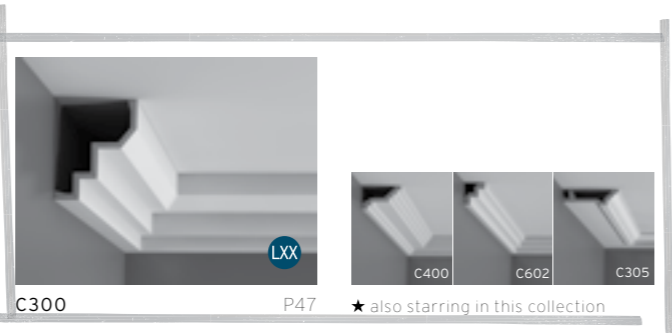

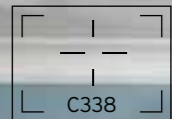
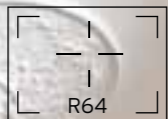
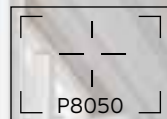

Take 1, lisbon



C338



P47

★ also starring in this collection



R64

P89



also starring in this collection ★



C336

P48



also starring in this collection ★



P8050

P62



also starring in this collection ★



SX118

also starring in this collection ★

SX156

P69

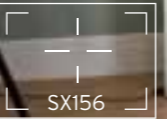
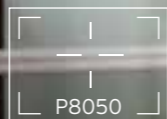
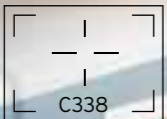
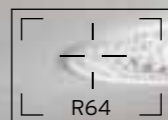
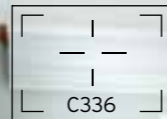

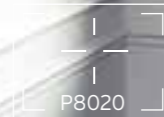
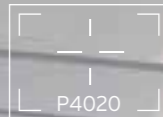

C990

P46



★ also starring in this collection  
designed by Xavier Donck

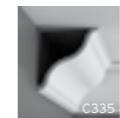

also starring in this collection ★



C219

P50



P9010

P61



also starring in this collection ★



P8030

P60



P4020

P60



PX103

P66



SX118

P69

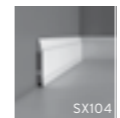

★ also starring in this collection

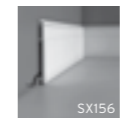

also starring in this collection ★



SX155

P69

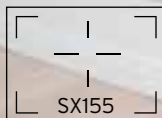
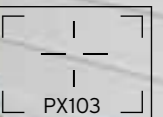
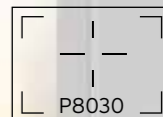
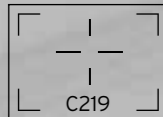

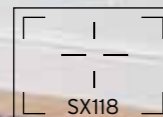
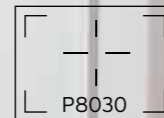
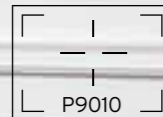
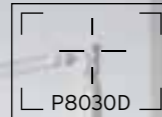
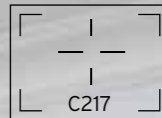

C217



P45

★ also starring in this collection



P8030D

P62



P9010

P61



P8030

P60



C307+C307A

P50

London Notting Hill



SX118

P69

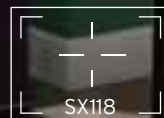
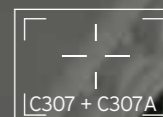

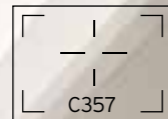

also starring in this collection ★  
designed by Pierre Daems



C364 P58/101



also starring in this collection ★



DX163-2300 P67/69



C357 P58/P101



★ also starring in this collection  
designed by Jaques Vergracht

*Indirect lighting  
Paris* →

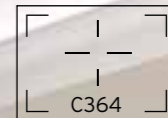

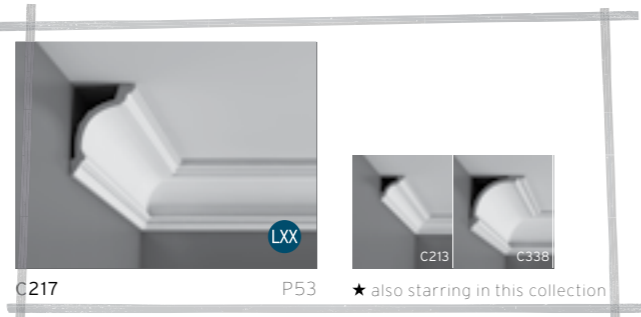

C217 P53 ★ also starring in this collection

Dressing Lady...  
Cambridge



SX118 P66 ★ also starring in this collection



also starring in this collection ★



CX106 P53



H101 P81



also starring in this collection ★

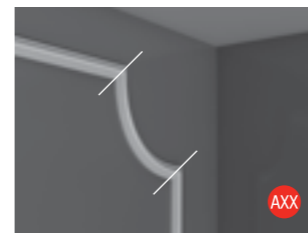

PX103/PX103A P66



PX113 P66  
PX103 P66  
SX118 P69

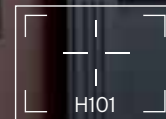
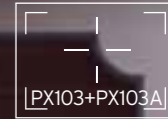

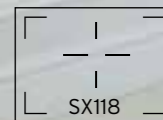
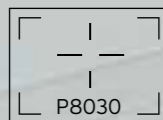
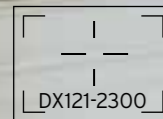
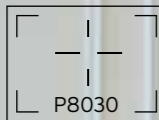
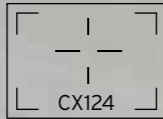

Chateau Mont-Royal  
Chantilly



CX124

P52

★ also starring in this collection



P8030

P60

★ also starring in this collection



C322

P45



DX121-2300

P72

★ also starring in this collection



R08

P86



SX118

P69

★ also starring in this collection



P8030/8030F

P60

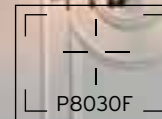
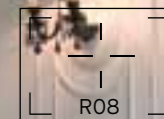
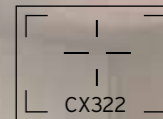

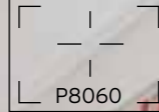
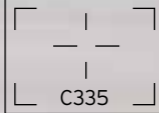

ORAC DECOR

ORAC DECOR



C335



C337

P47

P47

*Majestic Barcelona*



P8060

P60





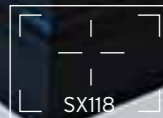
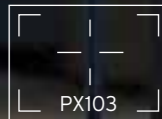
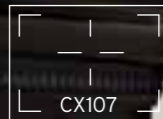

CX107

P53



PX103

P66



CX107

P53



SX118

P69



P9010

P61



PX120

P66

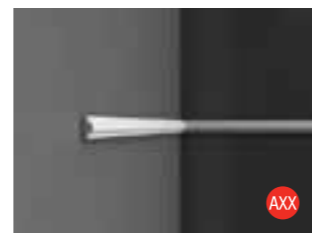

PX103

P66



SX156

P69

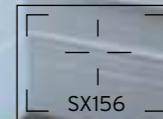
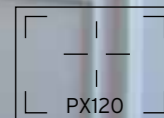
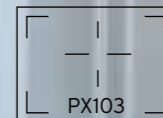
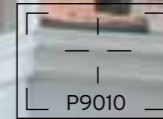

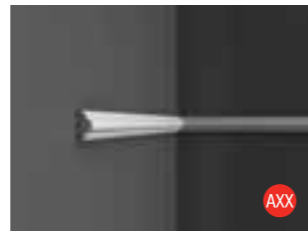
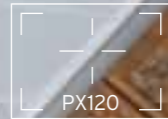

PX120

P66

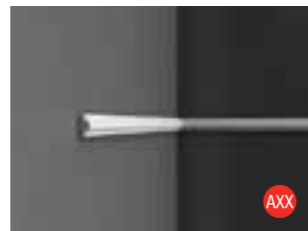

PX103

P66

Lounge  
Boca Grande

Boca Grande  
Barcelona

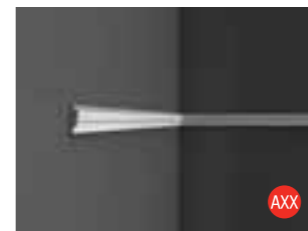

PX116

P66

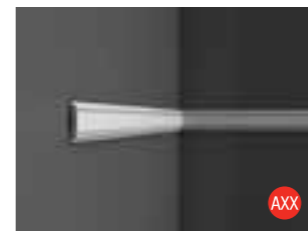

PX144

P66

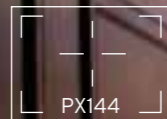
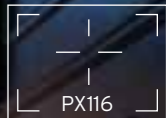
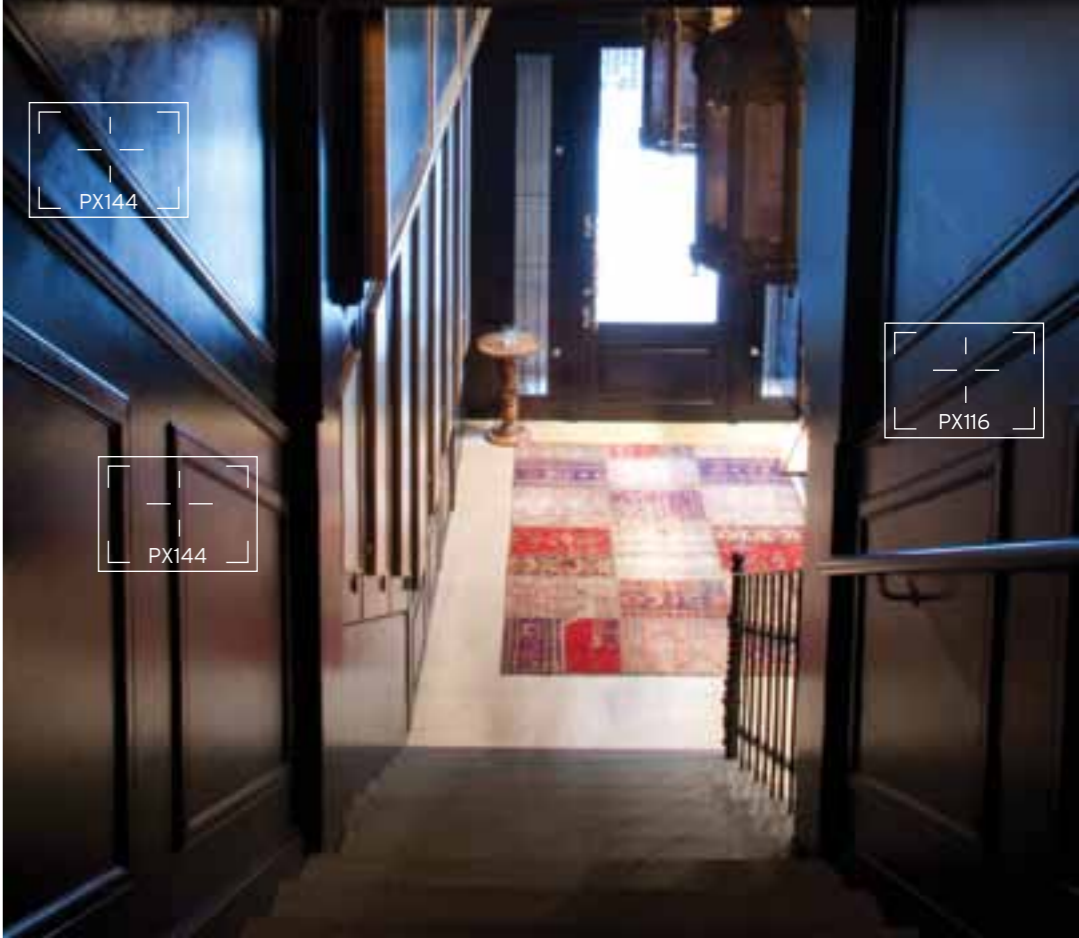
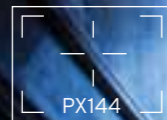



also starring in this collection ★



C334

P47

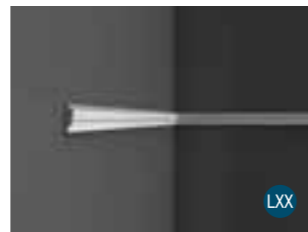

P9901

P47/60

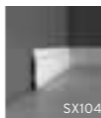

also starring in this collection ★



SX156

P69





C354

P42



C356 C353 C355

★ also starring in this collection

← Hamburg



C360

P42

Hotel Alma Barcelona



PX120

P66



C901

P45



P8030

P60



SX118

P69



PX120



C901



P8030



SX118



# LUXXUS

## COLLECTION



### NL

Binnen het overkoepelende merk ORAC DECOR® neemt Luxxus een exclusieve plaats in. Het gamma omvat dan ook een uniek aanbod van luxe creatieve profielen en decoratieve accessoires. Een compleet gamma voor een totaalconcept in stijl: van kroon- en wandlijsten over plinten en lambrisering tot verlichtingssystemen en deurdecoratie, telkens met dat tikkeltje meer.

De verschillende moulures vinden elkaar in een sterk visuele impact. Zo bepalen ze mee de sfeer binnenshuis met hun opvallende look, hun reliëf of hun opmerkelijke grootte. Kortom, ideaal om een interieur een niet-alledaagse finishing touch te geven. De volledige lijn wordt bovendien continu aangevuld met vernieuwende ideeën en creaties van topdesigners.

Niet alleen een buitengewoon design maar ook een onberispelijke kwaliteit kenmerkt Luxxus. De moulures zijn vervaardigd van kwalitatieve kunststoffen als Purotouch® (hoogwaardig polyurethaan) en Duropolymer® (een polymeer met hoge densiteit). Materialen die hun kwaliteit ruimschoots bewezen hebben én die een vlotte plaatsing toelaten.

### FR

Occupant une place exclusive dans la marque ORAC DECOR®; la gamme Luxxus comprend une offre inédite de profilés créatifs et d'accessoires décoratifs de luxe: moulures de plafond et murales, plinthes, lambris, décorations de portes et systèmes d'éclairage... Bref, une gamme complète pour un concept

total esthétique, qui se distingue par son style. Combinées, les différentes moulures ont un impact visuel puissant et élégant. Originales, travaillées ou monumentales, elles contribuent à définir l'atmosphère de votre intérieur, à lui donner l'accent qui fera sa finition magistrale. La gamme étendue est complétée en permanence par des idées et créations innovantes de concepteurs de pointe.

La gamme Luxxus se distingue par son design exceptionnel et sa qualité irréprochable. Les moulures sont fabriquées dans des matières synthétiques de qualité supérieure, telles que le Purotouch® (un polyuréthane haut de gamme) et Duropolymer® (un polymère haute densité). Des matériaux dont la qualité éprouvée autorise un placement rapide.

### EN

Luxxus occupies an exclusive position within the overall ORAC DECOR® brand, as it contains a unique selection of luxury creative profiles and decorative accessories. A complete range to provide a total concept with real style - from cornices and panel mouldings, skirting-boards and wainscoting to lighting systems and door furniture, all with that little extra something.

The different mouldings are united in their strong visual impact, which means they help set the tone of your interior with their striking looks and contours or their conspicuous dimensions. In short, the ideal way to put that out-of-the-ordinary finishing touch to your decor. And what is more, we are continually adding innovative ideas and creations from top designers. It's not just its remarkable design but also

its impeccable quality that makes Luxxus so special. The mouldings are made from top quality plastics such as Purotouch® (high-grade polyurethane) and Duropolymer® (a high-density polymer) - materials of well-proven quality that also allow easy fitting.

### DE

Innerhalb der übergeordneten Marke ORAC DECOR® nimmt Luxxus einen exklusiven Platz ein. Das Programm enthält ein einzigartiges Angebot luxuriöser kreativer Profile und dekorativer Zubehörteile. Ein komplettes Programm für ein stilvolles Gesamtkonzept: von Eck- und Wandleisten über Sockelleisten bis hin zu Beleuchtungssystemen und Türdekorationen, jeweils mit dem gewissen Etwas.

Die verschiedenen Zierleisten haben alle eine stark visuelle Wirkung. Sie bestimmen die Atmosphäre im Haus mit ihrem auffallenden Look, ihrem Relief oder ihrer bemerkenswerten Größe. Kurzum, ideal, um einem Interieur einen nicht alltäglichen Finishing Touch zu geben. Die vollständige Reihe wird darüber hinaus kontinuierlich um erneuernde Ideen und Kreationen von Spitzendesignern ergänzt.

Nicht nur ein außergewöhnliches Design, sondern auch eine makellose Qualität kennzeichnet Luxxus. Die Zierleisten werden aus Qualitätskunststoffen wie Purotouch® (hochwertiges Polyurethan) und Duropolymer® (ein Polymer mit hoher Dichte) hergestellt. Dieses Material hat seine Qualität bewiesen und erlaubt eine reibungslose Anbringung.

### ES

La máxima aspiración de ORAC DECOR® es seguir sorprendiéndole cada año con productos que destaquen, tanto en calidad como en innovación y tecnología. Los 40 años de experiencia nos colocan en una situación privilegiada y, podemos afirmar que la marca ORAC DECOR® se ha convertido en una marca europea que marca tendencia en el mundo de los perfiles arquitectónicos para la decoración, tanto para el interior, como para el exterior.

Todo el equipo de ORAC DECOR® se centra en la búsqueda constante de nuevas ideas, tecnologías y diseños con el objetivo de aportar a nuestros clientes las opciones necesarias para los diferentes estilos de decoración, así como múltiples soluciones prácticas en las instalaciones. Procuramos siempre adaptar la comodidad a la sencillez del uso, la calidad a la fiabilidad y lo tradicional a lo innovador.

Los retos del futuro nos obligan a una completa orientación al mercado, escuchando constantemente las propuestas y sugerimientos que nos hacen nuestros clientes, tanto arquitectos, interioristas, decoradores, profesionales aplicadores o consumidores finales.

En ORAC DECOR® intentamos mantener un constante estado de renovación, tanto en diseños como en soluciones creativas, así como en aplicar las tecnologías más ingeniosas, desarrolladas por nuestros ingenieros. En este sentido, desde los años 70 nuestra línea Luxxus nos ofrece como primera marca la esencia de los perfiles arquitectónicos más elegantes y señoriales.



# AXXENT

COLLECTION

NL

Axxent, een collectie van ORAC DECOR®, is een kwaliteitsvol assortiment oplossingslijsten. Een totaalgamma dat de vakman helpt om kwaliteitswerk te leveren tegen een betaalbare prijs. Een assortiment van kroon- en wandlijsten, plinten, deuromlijstingen en multifunctionele lijsten. Ontdek nu een wereld van mogelijkheden en oplossingen met Axxent.

Alle Axxent producten bestaan uit Duropolymer®, een geëxtrudeerde, stoof- en waterbestendige polymermix van hoge dichtheid. Hét ideale materiaal voor plinten en deuromlijstingen. Bovendien is Duropolymer® 100% recycleerbaar.

FR

Axxent, une collection d'ORAC DECOR®, est un choix de moulures universelles de qualité. Une gamme complète pour fournir un travail de qualité à un prix abordable. Un choix de corniches, de cimaises, de plinthes, d'encadrements de porte et de moulures multifonctionnelles. Découvrez aujourd'hui un univers pleins de possibilités et de solutions avec Axxent.

Tous les produits Axxent sont réalisés en Duropolymer®, un mélange de polymères extrudés de haute densité, résistant aux chocs et à l'eau. Le matériau idéal pour les plinthes et les encadrements de porte. En plus: Duropolymer® est 100% recyclable.

EN

Axxent, a collection by ORAC DECOR®, is a high-quality, solution-oriented range of mouldings. This complete range helps skilled decorators to deliver first-rate work at an affordable price. It includes cornice and panel mouldings, door frames and multifunctional profiles. Discover a world of possibilities and solutions with Axxent.

All Axxent products are made from Duropolymer®, an extruded, impact and water resistant high-density polymer blend. It's the perfect material for skirting and door frames. Another important advantage: Duropolymer® is 100% recyclable.

DE

Axxent, eine Kollektion aus Orac Decor®, ist ein qualitativ hochwertiges Sortiment von Zierleisten. Eine Kollektion, mit dem der Fachmann Qualitätsarbeit preiswert anbieten kann. Ein Sortiment aus Eck- und Wandleisten, Sockelleisten, Türumrandungen und multifunktionalen Profilen. Entdecken Sie eine Welt der zahllosen Möglichkeiten und funktionellen Lösungen mit Axxent.

Alle Axxent Produkte bestehen aus Duropolymer®, einer extrudierten, stoß- und wasserfesten Polymischung mit hoher Dichte. Das ideale Material für Sockelleisten und Türumrandungen. Ein weiterer Vorteil: Duropolymer® ist 100 % recyclebar.

ES

Axxent, una de las colecciones de ORAC DECOR®, es una gama de alta calidad, pensada para ofrecer soluciones. Esta gama ayuda a decoradores e interioristas a ofrecer valor añadido en sus proyectos a un precio accesible. Incluye cornisas, molduras, marcos para puerta y perfiles multifuncionales. Descubra Orac Axxent.

La línea Axxent utiliza la tecnología llamada Duropolymer®, una mezcla extruida de polímero de alta densidad, resistente al agua y a los golpes. Es el material perfecto para zócalos y marcos para puerta. Otra ventaja importante: Duropolymer® es 100% reciclable.

ORAC  
DECOR



ORAC  
DECOR

# BASIXX

COLLECTION

NL

Met de Basixx collectie spreekt ORAC DECOR® sinds zijn lancering een jong en trendy publiek aan. Dankzij de introductie van 5 nieuwe modellen wordt de collectie nu écht compleet. Een inventieve, originele en budgetvriendelijke collectie die op een tijdloze manier elk interieur afwerkt. Deze sierlijsten weten wand en plafond elegant te verbinden zodat het spel van licht en schaduw kan losbarsten.

ORAC DECOR® koos ervoor om zijn klanten een eenvoudig concept aan te bieden en ontwikkelde hiervoor families met telkens verschillende kroonlijsten per type huis. Zo kan voor elke leefruimte in één en hetzelfde huis een lijst uit dezelfde familie gebruikt worden.

Alle Basixx producten bestaan uit Durofoam®, een geëxtrudeerde lichtgewicht polymeermix op basis van hoogkwalitatieve middendensiteitspolystyreen. Bovendien is Durofoam® 100% recycleerbaar.

FR

Avec la collection Basixx, ORAC DECOR® s'adresse depuis son lancement à un public jeune et branché. Et les 5 nouveaux modèles introduits complètent vraiment la collection. Une collection inventive, originale et à faible coût pour une finition intemporelle de n'importe quel intérieur. Ces moulures décoratives assurent une parfaite jonction mur/plafond qui laisse éclater le jeu d'ombres et de lumières. ORAC DECOR® a choisi de proposer à ses clients un concept simple, et a développé

pour ce faire des familles de plusieurs corniches chacune par type de maison. Le client peut ainsi utiliser une corniche de la même famille pour chaque espace de vie dans une seule et même maison.

Tous les produits Basixx sont réalisés en Durofoam®, un mix de polymère extrudé, moyenne densité, hautement qualitatif. En plus: Durofoam® est 100% recyclable.

EN

Since its launch, the Basixx collection by ORAC DECOR® has been addressing a young and trendy clientele. Thanks to the introduction of five new models the range is now really complete. An inventive, original and budget-friendly collection that completes each interior in a timeless way. These ornamental frames connect wall and ceiling elegantly so the play of light and shadow can burst out. ORAC DECOR® chose to offer its customers a simple concept for which it developed different families, each with different cornices per style. This way, products from the same family can be used for each room in the house.

All Axxent products are made from Durofoam®, an extruded lightweight polymer based on a medium-density polymer blend. Another important advantage: Durofoam® is 100% recyclable.

DE

Mit der Basixx-Kollektion spricht ORAC DECOR® seit deren Markteinführung ein junges und modeorientiertes Publikum an. Jetzt wurde die Kollektion mit fünf neuen Modellen abgerundet. Eine einfallsreiche, originelle, preiswerte Kollektion, die auf zeitlose Weise jeden Innenraum verschönert. Diese Zierleisten wissen Wand und Decke elegant zu verbinden, sodass das Spiel von Licht und Schatten freien Lauf nehmen kann. ORAC DECOR® beschloss, seinen Kunden ein einfaches Konzept zu bieten und entwickelte dafür gesonderte Stilfamilien mit jeweils verschiedene Eckleisten pro Familie. So können in einem Haus verschiedene Eckleiste aus derselben Familie verwendet werden um ein einheitlichen Stil zu generieren.

Alle Basixx Produkte bestehen aus Durofoam®, einer extrudiertes leichtes Polymer auf der Grundlage einer Polymischung mittlerer Dichte. Ein weiterer Vorteil: Durofoam® ist 100 % recyclebar.

ES

Desde su lanzamiento, ORAC DECOR® ha orientado la colección Basixx a un público joven y moderno. Ahora, gracias a la introducción de 5 nuevos modelos, la oferta queda completada. Una colección ingeniosa, original y asequible, que aporta un acabado atemporal a cualquier interior. Estas cornisas unen con elegancia la pared y el techo dejando estallar un juego de luces y sombras. ORAC DECOR® ha optado por ofrecer a

sus clientes un concepto sencillo; para ello hemos agrupado las referencias en familias, una para cada tipo de hogar; de esta forma se puede personalizar con un modelo diferente pero con el mismo estilo de decoración.

La línea Basixx utiliza la tecnología llamada Durofoam®, una mezcla extruida de polímero. Otra ventaja importante: Durofoam® es 100% reciclable.

041





C360

PUROTOUCH®  
200 x 2 x 6 cm

LXX

C356

PUROTOUCH®  
200 x 2 x 10 cm

LXX

C353

PUROTOUCH®  
200 x 3 x 16,5 cm

LXX

C355

PUROTOUCH®  
200 x 3,5 x 11 cm

LXX

C305

PUROTOUCH®  
200 x 4,5 x 15,5 cm

LXX

C305 + C212

PUROTOUCH®

LXX

C305 + C213

PUROTOUCH®

LXX

C305 + C321

PUROTOUCH®

LXX



C354

PUROTOUCH®  
200 x 4 x 21,5 cm

LXX

C250/C250F

PUROTOUCH®  
200 x 1,5 x 1,5 cm

LXX FLEX

C230/C230F

PUROTOUCH®  
200 x 3 x 3 cm

LXX FLEX

C260/C260F

PUROTOUCH®  
200 x 4 x 5 cm

LXX FLEX

C305 + C211

PUROTOUCH®

LXX

C215/C215F

PUROTOUCH®  
200 x 4,5 x 4,5 cm

LXX FLEX

C322/C322F

PUROTOUCH®  
200 x 5 x 4 cm

LXX FLEX

C602/C602F

PUROTOUCH®  
200 x 5,5 x 5 cm

LXX FLEX



C400

PUROTOUCH®  
200 x 6 x 10 cm

LXX

∇ = 11,7



C331/C331F

PUROTOUCH®  
200 x 6 x 13,5 cm

LXX FLEX

∇ = 14,8



C200/C200F

PUROTOUCH®  
200 x 6,5 x 5,5 cm

LXX FLEX

∇ = 8,4



C220/C220F

PUROTOUCH®  
200 x 7,5 x 11,5 cm

LXX FLEX

∇ = 13,7



C217/C217F

PUROTOUCH®  
200 x 15,5 x 10,5 cm

LXX FLEX

∇ = 18,7



C332

PUROTOUCH®  
200 x 23 x 11,5 cm

LXX

∇ = 25,7



C333/C333F

PUROTOUCH®  
200 x 12 x 11 cm

LXX FLEX

∇ = 16,5



C339/C339F

PUROTOUCH®  
200 x 14 x 6 cm

LXX NEW FLEX

∇ = 15,2



C213/C213F

PUROTOUCH®  
200 x 8 x 8 cm

LXX FLEX

∇ = 11,3



C240/C240F

PUROTOUCH®  
200 x 8 x 8 cm

LXX FLEX

∇ = 11,3



C321/C321F

PUROTOUCH®  
200 x 10 x 5 cm

LXX FLEX

∇ = 11,2



C902/C902F

PUROTOUCH®  
200 x 10 x 10 cm

LXX FLEX

∇ = 14,1



C334/C334F

PUROTOUCH®  
200 x 15 x 19,5 cm

LXX FLEX

∇ = 24,6



C901/C901F

PUROTOUCH®  
200 x 15 x 12,5 cm

LXX FLEX

∇ = 19,5



C217/C217F

PUROTOUCH®  
200 x 15,5 x 10,5 cm

LXX FLEX

∇ = 18,7



C900

PUROTOUCH®  
200 x 17 x 14,5 cm

LXX

∇ = 22,6



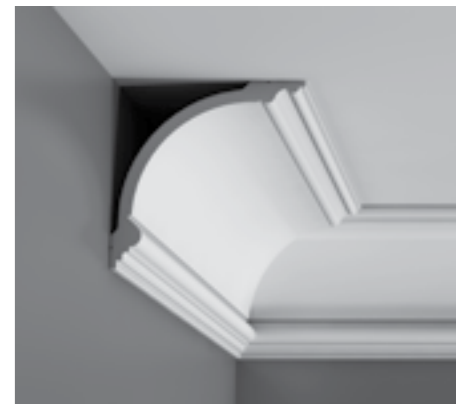
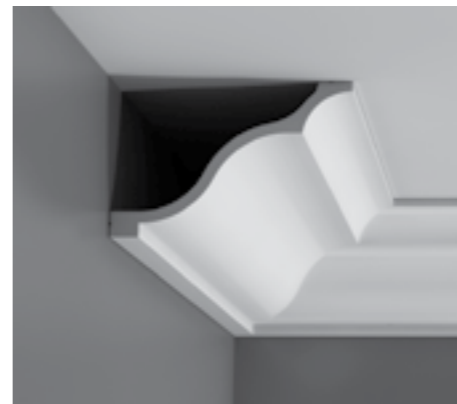
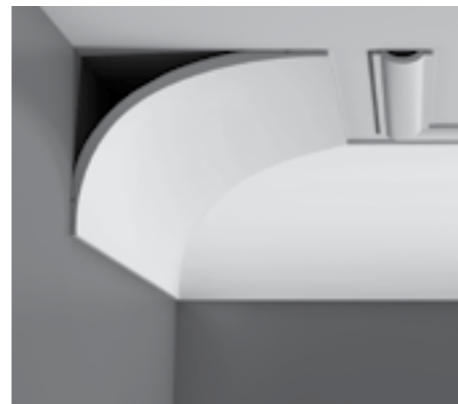
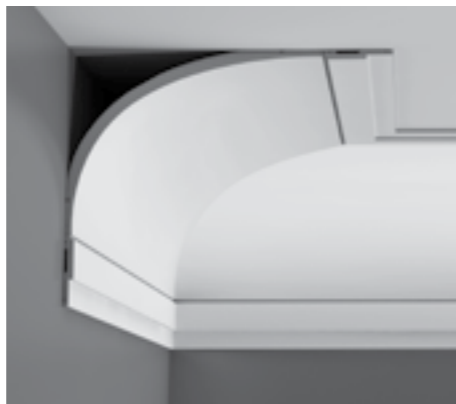
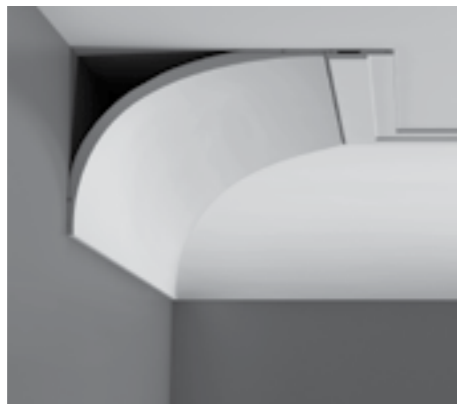
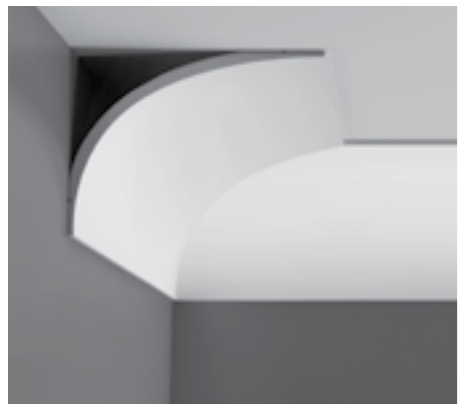

C990 - Designed by Xavier Donck

C990 + P9900 - Designed by Xavier Donck

C990 + 2x P9900 - Designed by Xavier Donck

C990 + P9900 - Designed by Xavier Donck

C990 + P9901 - Designed by Xavier Donck

C337

C300

C338

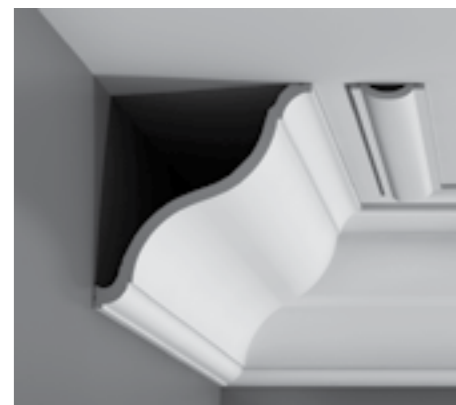
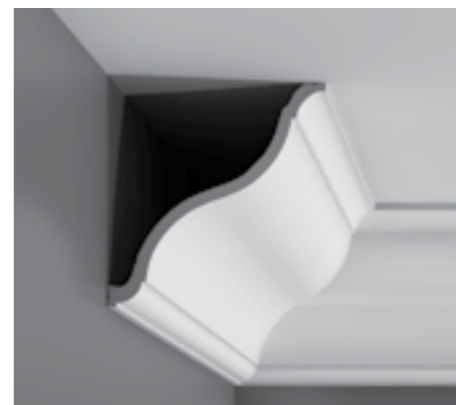
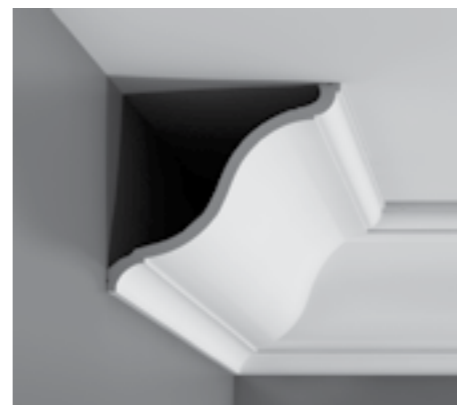
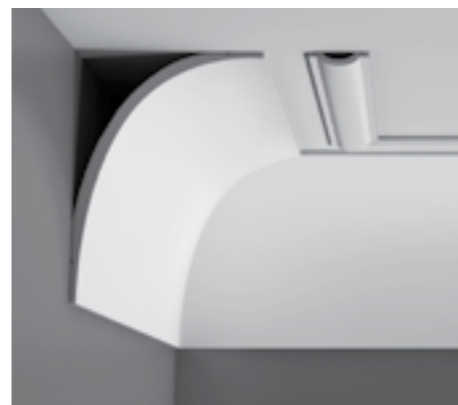
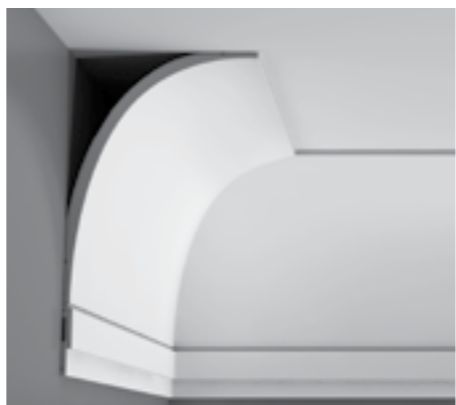
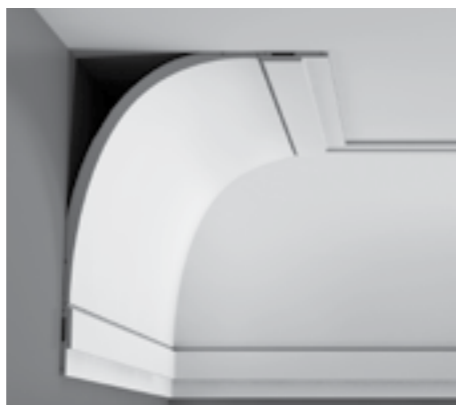
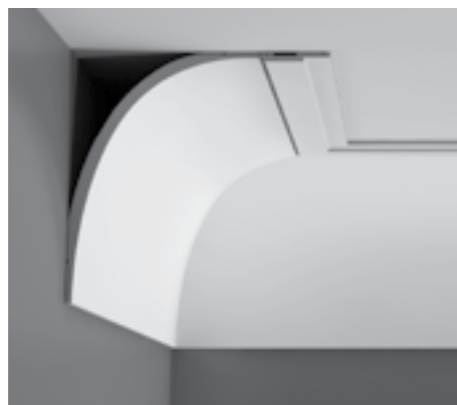
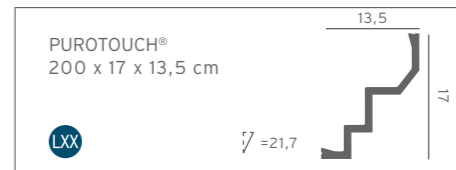
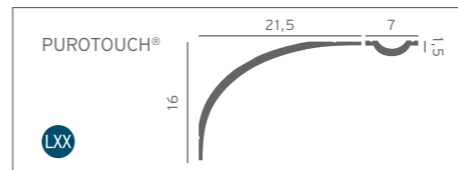
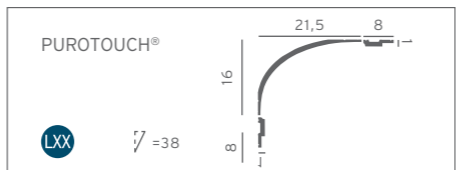
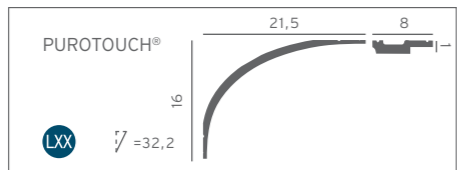
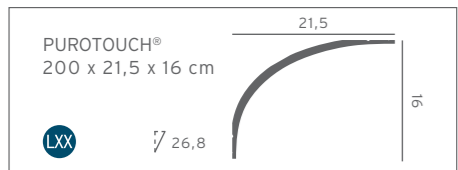

C990 - Designed by Xavier Donck

C990 + P9900 - Designed by Xavier Donck

C990 + 2x P9900 - Designed by Xavier Donck

C990 + P9900 - Designed by Xavier Donck

C990 + P9901 - Designed by Xavier Donck

C335 - Designed by Xavier Donck

C335 - Designed by Xavier Donck

C335 + P9901 - Designed by Xavier Donck

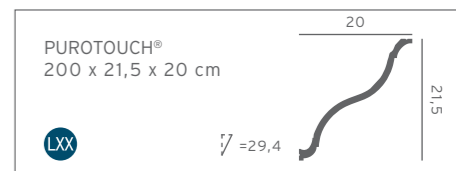
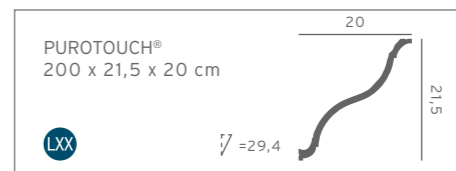
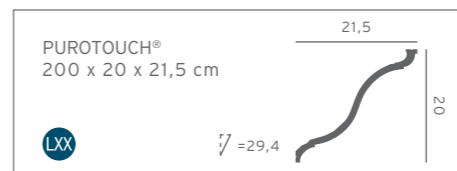
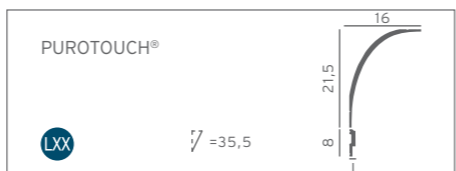
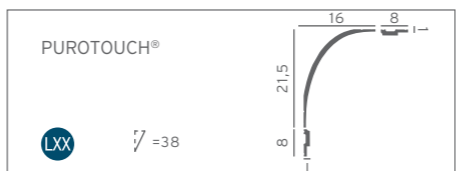
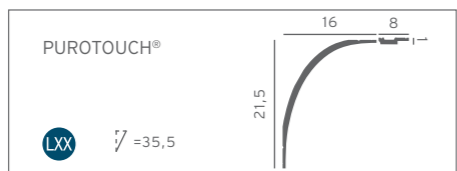
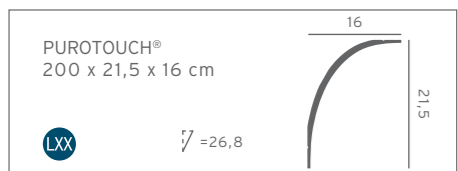



C332

PUROTOUCH®  
200 x 23 x 11,5 cm

LXX NEW  $\nabla = 25,7$

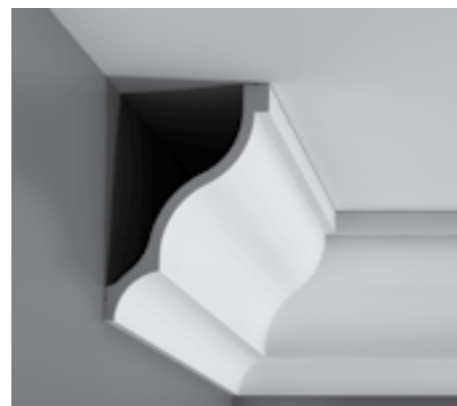

C337

PUROTOUCH®  
200 x 16,5 x 25 cm

LXX NEW  $\nabla = 30$



C340

PUROTOUCH®  
200 x 25,5 x 13,5 cm

LXX NEW  $\nabla = 28,7$

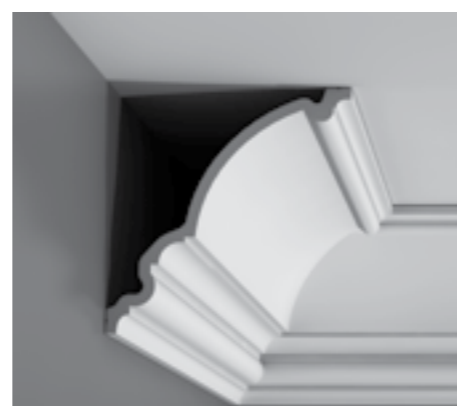

C336

PUROTOUCH®  
200 x 27 x 26 cm

LXX  $\nabla = 37,5$



C214/C214F

PUROTOUCH®  
200 x 6,5 x 3 cm

LXX FLEX  $\nabla = 7,2$



C212/C212F

PUROTOUCH®  
200 x 7,5 x 4 cm

LXX FLEX  $\nabla = 8,5$



C402/C402F

PUROTOUCH®  
200 x 9,5 x 10,5 cm

LXX FLEX  $\nabla = 14,4$

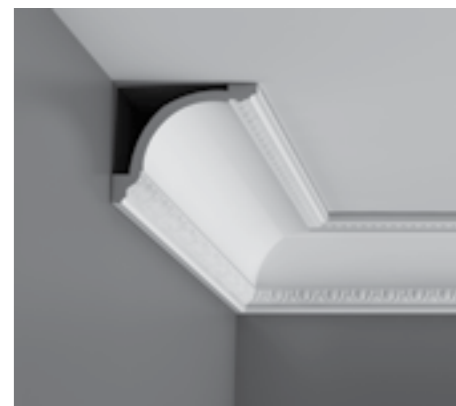

C216/C216F

PUROTOUCH®  
200 x 11,5 x 13,5 cm

LXX FLEX  $\nabla = 17,7$



C201/C201F

PUROTOUCH®  
200 x 11,5 x 5 cm

LXX FLEX  $\nabla = 12,5$



C211/C211F

PUROTOUCH®  
200 x 11,5 x 11 cm

LXX FLEX  $\nabla = 15,9$



C304/C304F

PUROTOUCH®  
200 x 12 x 7 cm

LXX FLEX  $\nabla = 13,9$



C302/C302F

PUROTOUCH®  
200 x 12,5 x 8 cm

LXX FLEX  $\nabla = 14,8$

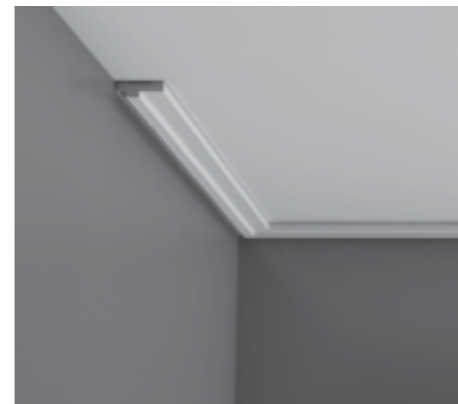

C303/C303F

PUROTOUCH®  
200 x 14 x 6,5 cm

LXX FLEX

∇ = 15,4

C218/C218F

PUROTOUCH®  
200 x 15 x 13 cm

LXX FLEX

∇ = 19,8

C422

PUROTOUCH®  
200 x 17 x 19,5 cm

LXX

∇ = 25,9

C301/C301F

PUROTOUCH®  
200 x 17 x 14 cm

LXX FLEX

∇ = 22

CX160

DUROPOLYMER®  
200 x 1,3 x 4 cm

AXX NEW

∇ = 4,2

CX161

DUROPOLYMER®  
200 x 1,3 x 7 cm

AXX NEW

∇ = 11,3

CX132

DUROPOLYMER®  
200 x 2 x 2 cm

AXX

∇ = 2,8

CX133

DUROPOLYMER®  
200 x 2 x 2 cm

AXX

∇ = 2,8

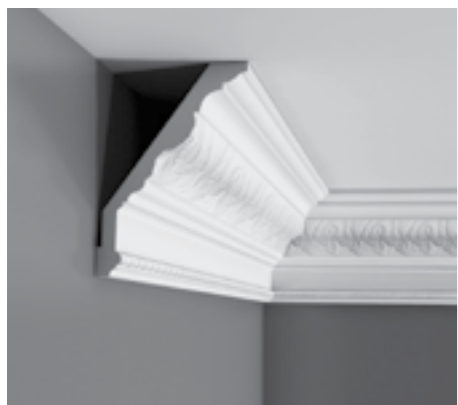

C219

PUROTOUCH®  
200 x 17,5 x 13 cm

LXX

∇ = 21,9

C307

PUROTOUCH®  
200 x 19 x 19 cm

LXX

∇ = 26,9

C307 + C307A

C307 PUROTOUCH®  
C307A DUROPOLYMER®  
C307 - 200 x 19 x 19 cm  
C307A - 7,5 x 9,5 x 4 cm

LXX

∇ = 26,9

C308/C308F

PUROTOUCH®  
200 x 25 x 6 cm

LXX FLEX

∇ = 25,7

CX111

DUROPOLYMER®  
200 x 2,5 x 1,5 cm

AXX

∇ = 2,9

PX164

DUROPOLYMER®  
200 x 3 x 2,5 cm

AXX

∇ = 3,9

CX115

DUROPOLYMER®  
200 x 3 x 3 cm

AXX

∇ = 4,2

CX154

DUROPOLYMER®  
200 x 3 x 3 cm

AXX

∇ = 4,2



CX148  
 DUROPOLYMER®  
 200 x 3 x 4,5 cm  
 $\nabla = 5,4$

CX110  
 DUROPOLYMER®  
 200 x 4,5 x 4 cm  
 $\nabla = 6$

CX109  
 DUROPOLYMER®  
 200 x 4,5 x 4,5 cm  
 $\nabla = 6,4$

CX124  
 DUROPOLYMER®  
 200 x 5 x 5 cm  
 $\nabla = 7,1$

CX126  
 DUROPOLYMER®  
 200 x 9 x 9 cm  
 $\nabla = 12,7$

CX127  
 DUROPOLYMER®  
 200 x 9,5 x 9,5 cm  
 $\nabla = 13,4$

CX106  
 DUROPOLYMER®  
 200 x 12 x 12 cm  
 $\nabla = 17$

CX101  
 DUROPOLYMER®  
 200 x 7 x 7 cm  
 $\nabla = 10$



CX112  
 DUROPOLYMER®  
 200 x 5,5 x 4 cm  
 $\nabla = 7,1$

CX108  
 DUROPOLYMER®  
 200 x 5,5 x 5,5 cm  
 $\nabla = 7,8$

CX100  
 DUROPOLYMER®  
 200 x 7 x 7 cm  
 $\nabla = 9,9$

CX123  
 DUROPOLYMER®  
 200 x 8 x 8 cm  
 $\nabla = 11,3$

CX136  
 DUROPOLYMER®  
 200 x 7 x 7 cm  
 $\nabla = 10$

CX128  
 DUROPOLYMER®  
 200 x 9,5 x 9,5 cm  
 $\nabla = 13,4$

CX129  
 DUROPOLYMER®  
 200 x 9,5 x 9,5 cm  
 $\nabla = 13,4$

CX107  
 DUROPOLYMER®  
 200 x 12 x 12 cm  
 $\nabla = 17$



DX162-2300

DUROPOLYMER®  
230 x 1 x 4 cm



4



DX159-2300

DUROPOLYMER®  
230 x 1,2 x 6 cm



6



DX157-2300

DUROPOLYMER®  
230 x 1,3 x 6,5 cm



6,5



DX163-2300

DUROPOLYMER®  
230 x 1,3 x 10 cm



10





CB500  
DUROFOAM®  
200 x 2,5 x 2 cm  
BXX  
∇ = 3,2

CB530  
DUROFOAM®  
200 x 2,7 x 1,5 cm  
BXX NEW  
∇ = 3,1

CB530  
DUROFOAM®  
200 x 2,7 x 1,5 cm  
BXX NEW  
∇ = 3,1

CB520  
DUROFOAM®  
200 x 3,5 x 3,5 cm  
BXX  
∇ = 5

CB531  
DUROFOAM®  
200 x 4,5 x 2,5 cm  
BXX NEW  
∇ = 5,2

CB521  
DUROFOAM®  
200 x 5 x 5 cm  
BXX  
∇ = 7,1

CB502  
DUROFOAM®  
200 x 6 x 5 cm  
BXX  
∇ = 7,8

CB522  
DUROFOAM®  
200 x 7 x 7 cm  
BXX  
∇ = 9,9

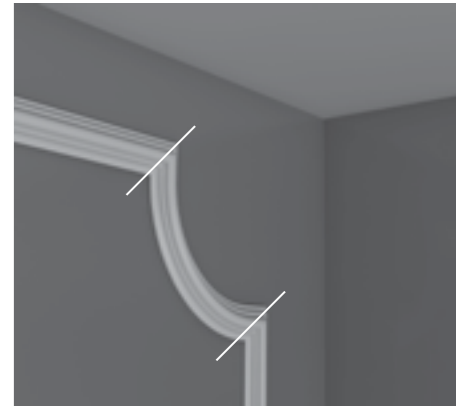
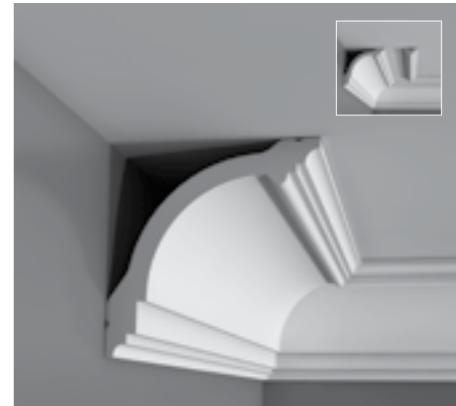
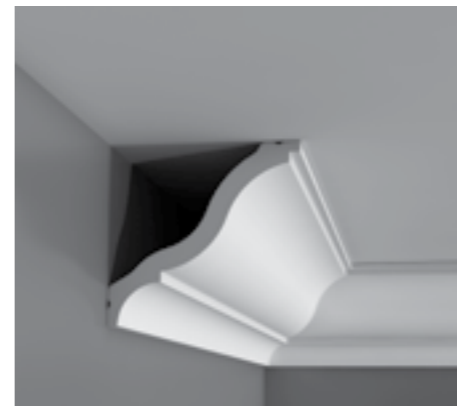

CB501  
DUROFOAM®  
200 x 4 x 3,5 cm  
BXX  
∇ = 5,3

CB510  
DUROFOAM®  
200 x 4 x 4 cm  
BXX  
∇ = 5,7

CB523  
DUROFOAM®  
200 x 6 x 4 cm  
BXX  
∇ = 7,2

CB531  
DUROFOAM®  
200 x 4,5 x 2,5 cm  
BXX NEW  
∇ = 5,2

CB511  
DUROFOAM®  
200 x 7 x 7 cm  
BXX  
∇ = 10

CB503  
DUROFOAM®  
200 x 8,5 x 9 cm  
BXX NEW  
∇ = 12,4

CB512  
DUROFOAM®  
CB512 - 200 x 10 x 10 cm  
PB513 - 200 x 1,7 x 3,5 cm  
BXX NEW  
∇ = 14,1

PB513 + PB513A  
PB513 - DUROFOAM®  
PB513A - DUROPOLYMER®  
PB513 - 200 x 1,7 x 3,5 cm  
PB513A - 18 x 7 x 1,5 cm  
BXX

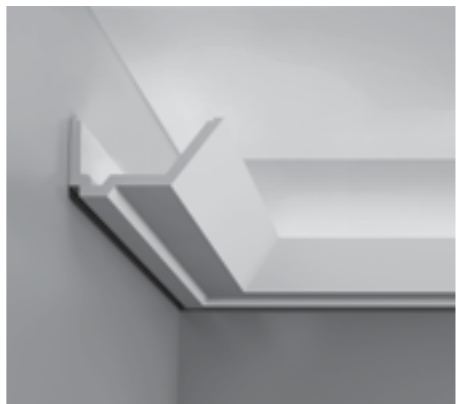
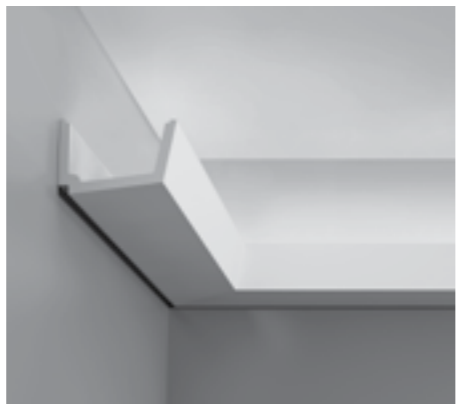
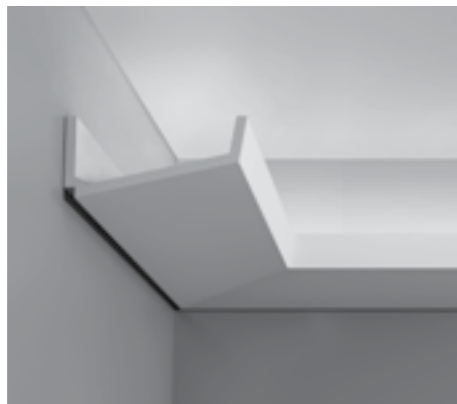
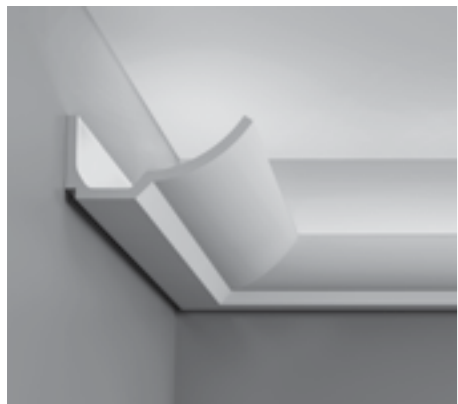

C351 - Designed by Jacques Vergracht

PUROTOUCH®  
200 x 8 x 17,5 cm

LXX FLEX

C352 - Designed by Jacques Vergracht

PUROTOUCH®  
200 x 7,5 x 17 cm

LXX

C357 - Designed by Jacques Vergracht

PUROTOUCH®  
200 x 7,5 x 11 cm

LXX

C358 - Designed by Jacques Vergracht

PUROTOUCH®  
200 x 7,5 x 14 cm

LXX

C900

PUROTOUCH®  
200 x 17 x 14,5 cm

LXX

C901

PUROTOUCH®  
200 x 15 x 12,5 cm

LXX FLEX

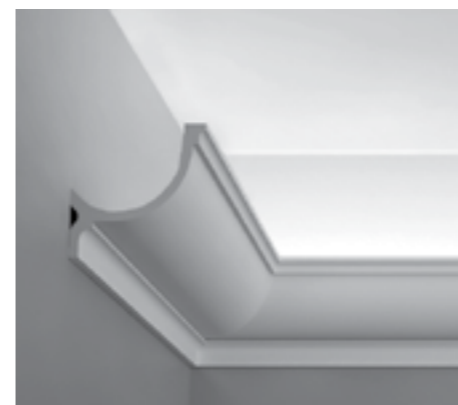
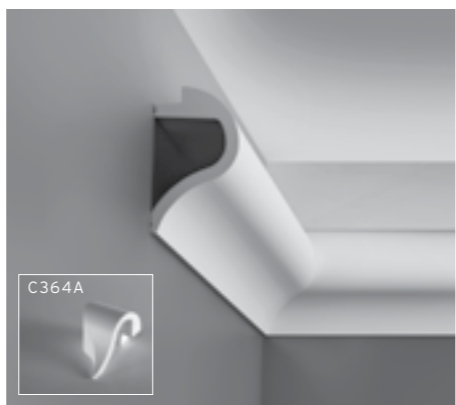

C361 - Designed by Pierre Daems

PUROTOUCH®  
200 x 5 x 5 cm

LXX NEW

C362 - Designed by Pierre Daems

PUROTOUCH®  
200 x 5 x 5 cm

LXX NEW

C364 - Designed by Pierre Daems

PUROTOUCH®  
200 x 14 x 8 cm

LXX NEW

C363 - Designed by Pierre Daems

PUROTOUCH®  
130 x 5 x 5 cm

LXX NEW

C902



PUROTOUCH®  
200 x 10 x 10 cm

LXX FLEX

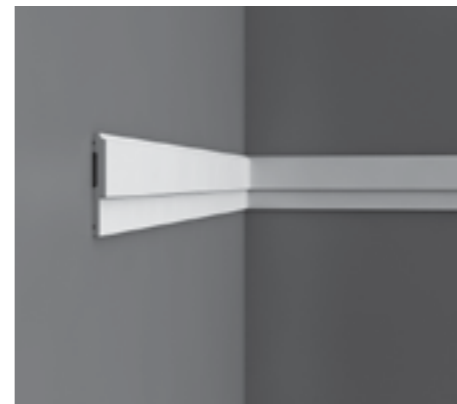
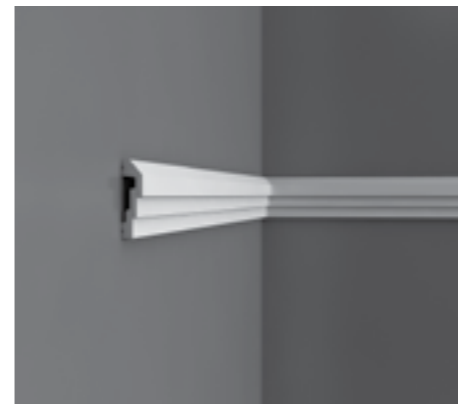
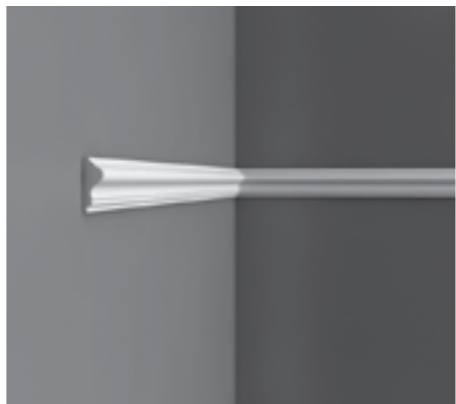
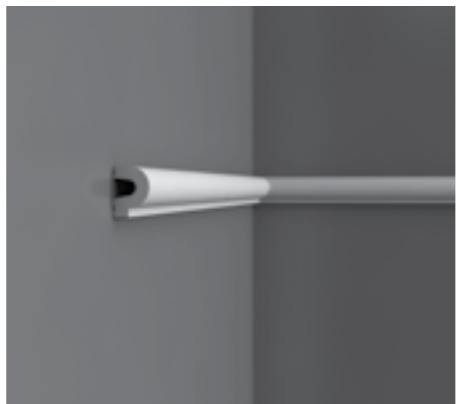











P9050/P9050F  
 PUROTOUCH®  
 200 x 2,5 x 1,5 cm  
  



P5021/P5021F  
 PUROTOUCH®  
 200 x 3 x 1 cm  
  



P8060/P8060F  
 PUROTOUCH®  
 200 x 3,5 x 5 cm  
   

P8030/P8030F  
 PUROTOUCH®  
 200 x 4 x 1,5 cm  
  



P7070/P7070F  
 PUROTOUCH®  
 200 x 7,5 x 2 cm  
  

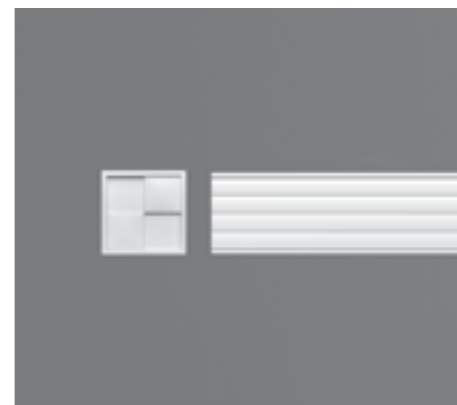
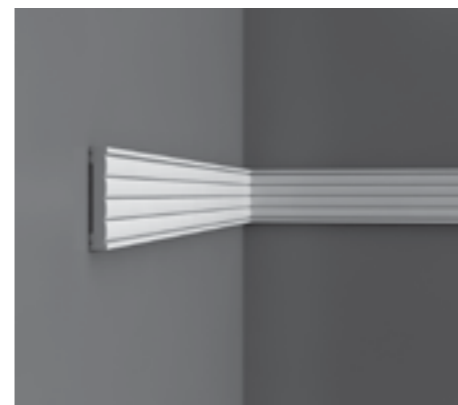
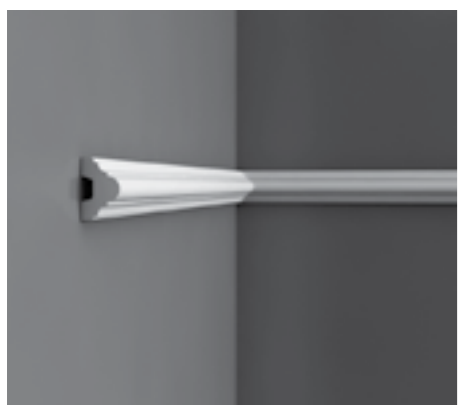

P9900/P9900F  
 PUROTOUCH®  
 200 x 8 x 1 cm  
  

P5051  
 PUROTOUCH®  
 200 x 8,5 x 1,5 cm  
 

P9010/P9010F  
 PUROTOUCH®  
 200 x 9 x 3 cm  
  



P4020/P4020F  
 PUROTOUCH®  
 200 x 5 x 3 cm  
  

P9040/P9040F  
 PUROTOUCH®  
 200 x 5 x 2,5 cm  
  



P8020/P8020F  
 PUROTOUCH®  
 200 x 6 x 2,5 cm  
  

P9901/P9901F  
 PUROTOUCH®  
 200 x 7 x 1,5 cm  
  

P5020/P5020F  
 PUROTOUCH®  
 200 x 9 x 1,5 cm  
  

P5020A  
 PUROTOUCH®  
 9 x 9 x 1,5 cm  
 endcap for P5020  
 

P5020B  
 PUROTOUCH®  
 9 x 9 x 1,5 cm  
 endcap for P5020  
  

P9020/P9020F  
 PUROTOUCH®  
 200 x 9,5 x 2 cm  
  



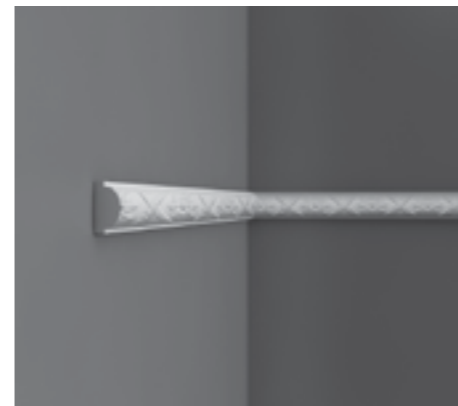
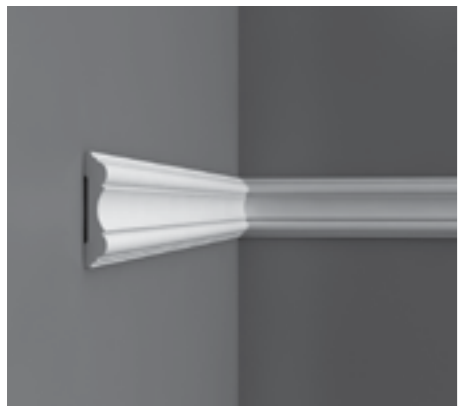

P8040/P8040F

PUROTOUCH®  
200 x 10 x 2 cm

LXX FLEX

P8050/P8050F

PUROTOUCH®  
200 x 12 x 3 cm

LXX FLEX

P5050

PUROTOUCH®  
200 x 20 x 1,5 cm

LXX

P8030D

DUROPOLYMER®  
13 x 13 x 1,5 cm

LXX FLEX

P2020/P2020F

PUROTOUCH®  
200 x 4,5 x 2,5 cm

LXX FLEX

P1020/P1020F

PUROTOUCH®  
200 x 5 x 2,5 cm

LXX FLEX

P7050/P7050F

PUROTOUCH®  
200 x 5,5 x 2,5 cm

LXX FLEX

P3020/P3020F

PUROTOUCH®  
200 x 6 x 3 cm

LXX

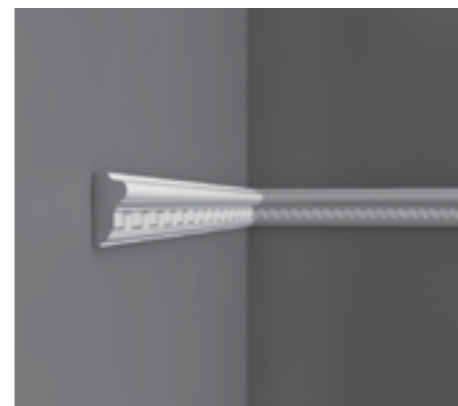
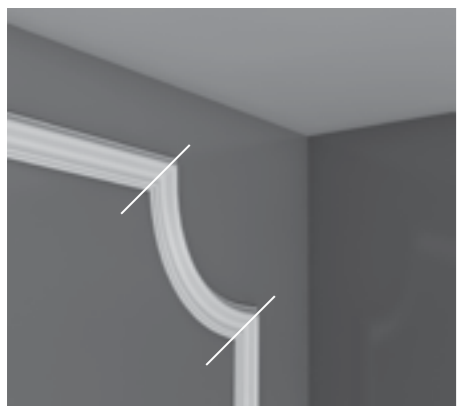

P8030C + P8030

P8030C-DUROPOLYMER®  
P8030-PUROTOUCH®

LXX

P4020A + P4020

PUROTOUCH®  
200 x 5 x 3 cm

LXX

P801C + P8020

PUROTOUCH®

LXX

P4020A

PUROTOUCH®  
16,5 x 7 x 3 cm

LXX

P6020/P6020F

PUROTOUCH®  
200 x 6,5 x 3 cm

LXX FLEX

P7060/P7060F

PUROTOUCH®  
200 x 7 x 2 cm

LXX FLEX

P7040/P7040F

PUROTOUCH®  
200 x 8 x 2,5 cm

LXX FLEX

P7030/P7030F

PUROTOUCH®  
200 x 8,5 x 1,5 cm

LXX FLEX



P2020/P2020F

PUROTOUCH®  
200 x 4,5 x 2,5 cm



P7010/P7010F

PUROTOUCH®  
200 x 10,5 x 2 cm



P21 + P201A

P21-DUROPOLYMER® + P201A-PUROTOUCH®  
P21: 6,5 x 6,5 x 1 cm  
P201A: 20 x 20 x 2,5 cm



P7020/P7020F

PUROTOUCH®  
200 x 11 x 2 cm



P1020/P1020F

PUROTOUCH®  
200 x 5 x 2,5 cm



P7080

PUROTOUCH®  
200 x 22 x 2 cm



P20 + P101A

P20-DUROPOLYMER® + P101A-PUROTOUCH®  
P20: diam. 6,5 cm  
P101: 25 x 25 x 2,5 cm



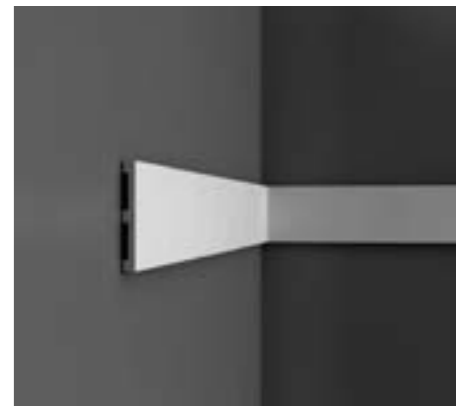
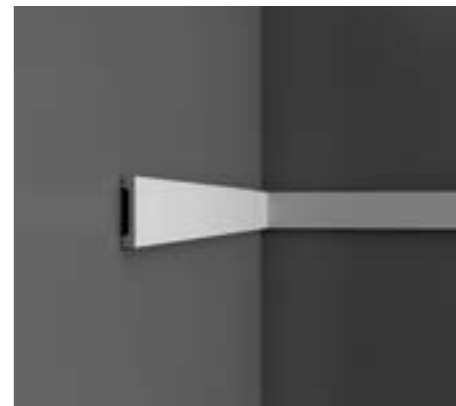
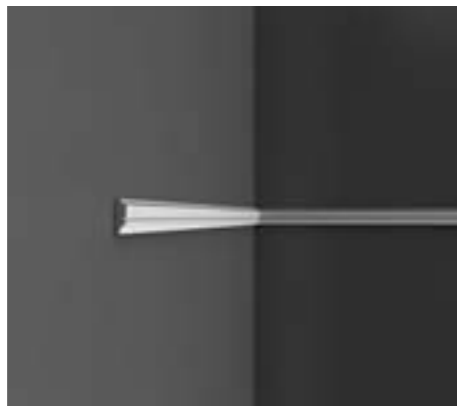

PX103

DUROPOLYMER®  
200 x 2,5 x 1,5 cm

PX116

DUROPOLYMER®  
200 x 3 x 1 cm

PX117

DUROPOLYMER®  
200 x 3,5 x 1,5 cm

PX131

DUROPOLYMER®  
200 x 4 x 2 cm

PX102

DUROPOLYMER®  
200 x 8 x 1,5 cm

DX162-2300

DUROPOLYMER®  
230 x 4 x 1 cm

DX157-2300

DUROPOLYMER®  
230 x 6,5 x 1,3 cm

DX163-2300

DUROPOLYMER®  
230 x 10 x 1,3 cm

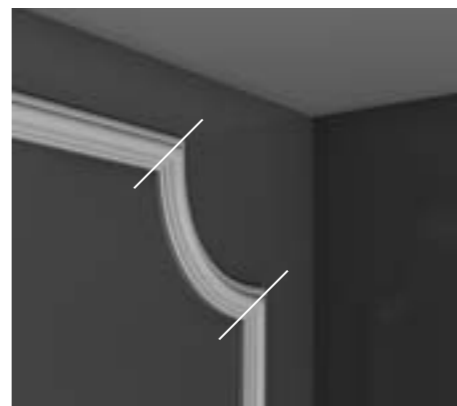

PX120

DUROPOLYMER®  
200 x 4 x 2 cm

PX144

DUROPOLYMER®  
200 x 5 x 1 cm

PX113

DUROPOLYMER®  
200 x 6 x 2,5 cm

PX114

DUROPOLYMER®  
200 x 6 x 2,5 cm

PX103A + PX103

PX103A-PUROTOUCH® + PX103-DUROPOLYMER®  
PX103 - 200 x 2,5 x 1,5 cm  
PX103A - 19 x 3,5 x 1,3 cm

PX120A + PX120

PX120A-PUROTOUCH® + PX120-DUROPOLYMER®  
PX120 - 200 x 4 x 2 cm  
PX120A - 19 x 5,7 x 2 cm

PX164

DUROPOLYMER®  
200 x 3 x 2,5 cm

for inner and outer corner use

CX134

DUROPOLYMER®  
200 x 3 x 3 cm



CX132

DUROPOLYMER®  
200 x 2 x 2 cm

AXX

CX133

DUROPOLYMER®  
200 x 2 x 2 cm

AXX

DX162-2300

DUROPOLYMER®  
230 x 4 x 1 cm

AXX

DX159-2300

DUROPOLYMER®  
230 x 6 x 1,2 cm

AXX

DX163-2300

DUROPOLYMER®  
230 x 10 x 1,3 cm

AXX

SX155/SX155F

DUROPOLYMER®  
200 x 11 x 2,5 cm

LXX FLEX

SX105/SX105F

DUROPOLYMER®  
200 x 11 x 1,3 cm

LXX FLEX

SX118/SX118F

DUROPOLYMER®  
200 x 14 x 1,8 cm

LXX FLEX



DX157-2300

DUROPOLYMER®  
230 x 6,5 x 1,3 cm

AXX

SX125

DUROPOLYMER®  
200 x 7 x 1,5 cm

AXX

SX122

200 x 8 x 2,2 cm

AXX

SX137

DUROPOLYMER®  
200 x 10 x 1,5 cm

AXX

SX138

DUROPOLYMER®  
200 x 14 x 1,5 cm

AXX

SX104

DUROPOLYMER®  
200 x 15 x 1,5 cm

LXX

SX156 - Designed by Xavier Donck

DUROPOLYMER®  
200 x 20 x 1,6 cm

LXX

SX155F

FLEX SKIRTING BOARD  
SX155F - SX105F - SX118F

LXX FLEX

DRINK  
**Coca-Cola**  
ICE COLD

Kroonlijsten / Corniches / Cornice  
Mouldings / Eckleisten / Cornisas

	Rmin	R*min
C200F	1,2 m	
C201F	1,6 m	/
C211F	2,5 m	/
C212F	1,4 m	/
C213F	1,8 m	/
C214F	1,0 m	/
C215F	1,6 m	/
C216F	3,4 m	/
C217F	3,4 m	/
C218F	3,5 m	/
C220F	2,0 m	/
C230F	1,0 m	/
C240F	2,0 m	/
C250F	0,8 m	/
C260F	1,3 m	/
C301F	3,0 m	/
C302F	2,6 m	/
C303F	1,8 m	/
C304F	1,8 m	/
C305F	3,4 m	/
C308F	1,4 m	/
C321F	1,4 m	/
C322F	1,2 m	/
C331F	4,2 m	/
C333F	3,3 m	/
C334F	3,8 m	/
C339F	2,4 m	/
C400F	3,0 m	/
C402F	1,5 m	/
C602F	1,3 m	/
C901F	3,8 m	/
C902F	3,8 m	/

Wandlijsten / Cimaises / Panel Mouldings  
/ Wand- und Friesleisten / Molduras

	Rmin	R*min
P1020F	0,4 m	1,2 m
P2020F	0,4 m	1,2 m
P3020F	0,8 m	1,8 m
P4020F	0,4 m	1,4 m
P5020F	0,4 m	/
P5021F	0,3 m	0,8 m
P6020F	0,4 m	2,0 m
P7010F	0,3 m	/
P7020F	0,3 m	/
P7030F	0,3 m	/
P7040F	0,5 m	/
P7050F	0,5 m	/
P7060F	0,4 m	/
P7070F	0,4 m	/
P8020F	0,5 m	2,0 m
P8030F	0,3 m	1,0 m
P8040F	0,3 m	/
P8050F	0,8 m	1,8 m
P8060F	0,8 m	2,0 m
P9010F	0,4 m	/
P9020F	0,4 m	/
P9040F	0,4 m	0,9 m
P9050F	0,3 m	1,0 m
P9900F	0,4 m	1,8 m
P9901F	0,4 m	1,8 m

Plinten / Plinthes / Skirting /  
Sockelleisten / Zócalos

	Rmin	R*min
SX105F	0,4 m	/
SX118F	0,4 m	/
SX155F	0,4 m	/

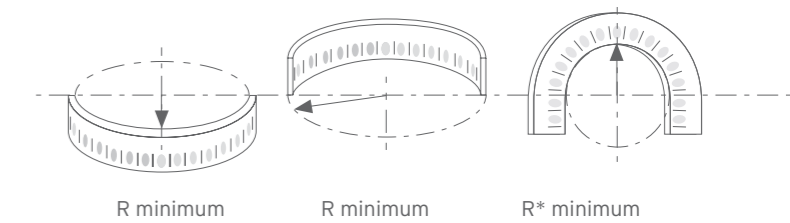

NL

ORAC FLEX, DE STIJLVOLLE OPLOSSING VOOR GEBOGEN EN AFGERONDE MUREN

Hierbij een overzicht van alle Orac Luxxus wand- en kroonlijsten en plinten die in flexibele polyurethaan gerealiseerd kunnen worden. Door deze buigzaamheid kunnen gebogen wanden en plafonds elegant afgewerkt worden. Men kan ook gebogen ornamenten op een vlakke wand of plafond aanbrengen. De flexibele lijsten zijn op dezelfde manier af te werken als de gewone lijsten. Installatie-instructies zijn verkrijgbaar.

FR

ORAC FLEX, LA SOLUTION ÉLÉGANTE POUR LES MURS CINTRÉS ET ARRONDIS

Voici un aperçu des corniches, cimaises et plinthes Orac Luxxus existantes qui sont réalisées dans un polyuréthane flexible. Par leur souplesse, elles permettent de décorer les murs et plafonds arrondis. Ces moulures peuvent être décorées de la même façon que les autres moulures. Des modes d'emploi sont disponibles.

EN

ORAC FLEX, THE ELEGANT SOLUTION FOR ROUNDED AND CURVED WALLS

Please find hereby an overview of all Orac Luxxus cornices, panel mouldings and skirting boards which can also be made out of flexible polyurethane. Thanks to the flexibility of this material, it is now possible to decorate rounded walls and ceilings elegantly. These cornice and wall mouldings can be finished using the same methods as with the normal polyurethane mouldings. Installation instructions are available.

DE

ORAC FLEX, DIE IDEALE LÖSUNG FÜR GEBOGENE WÄNDE UND RUNDUNGEN

Diese Übersicht zeigt Ihnen alle Orac Luxxus Wand-, Eck- und Sockelleisten, die in flexiblem Polyurethan erhältlich sind. Durch die Flexibilität der Profile können gebogene Wände und Decken elegant bearbeitet werden. Erstmals besteht die Möglichkeit, unebene Wände, Rundungen oder auch selbstentworfenen Kurvenverläufe entsprechend mit flexiblen Leisten zu dekorieren. Die flexiblen Profile sind auf die selben Art zu installieren wie die normalen PU-Profile. Installationshinweise sind erhältlich.

ES

ORAC FLEX, LA INNOVACIÓN DE ORAC PARA DAR SOLUCIÓN A INSTALACIONES CON CURVAS

Columnas, Arcos, etc. Presentamos una amplia gama de cornisas, molduras, y zócalos Orac Luxxus fabricados en poliuretano flexible. Por su flexibilidad, permiten dar soluciones en decoración a paredes y techos con curvas. Perfecta combinación entre el mismo modelo rígido y flexible. Consultar las instrucciones de instalación.

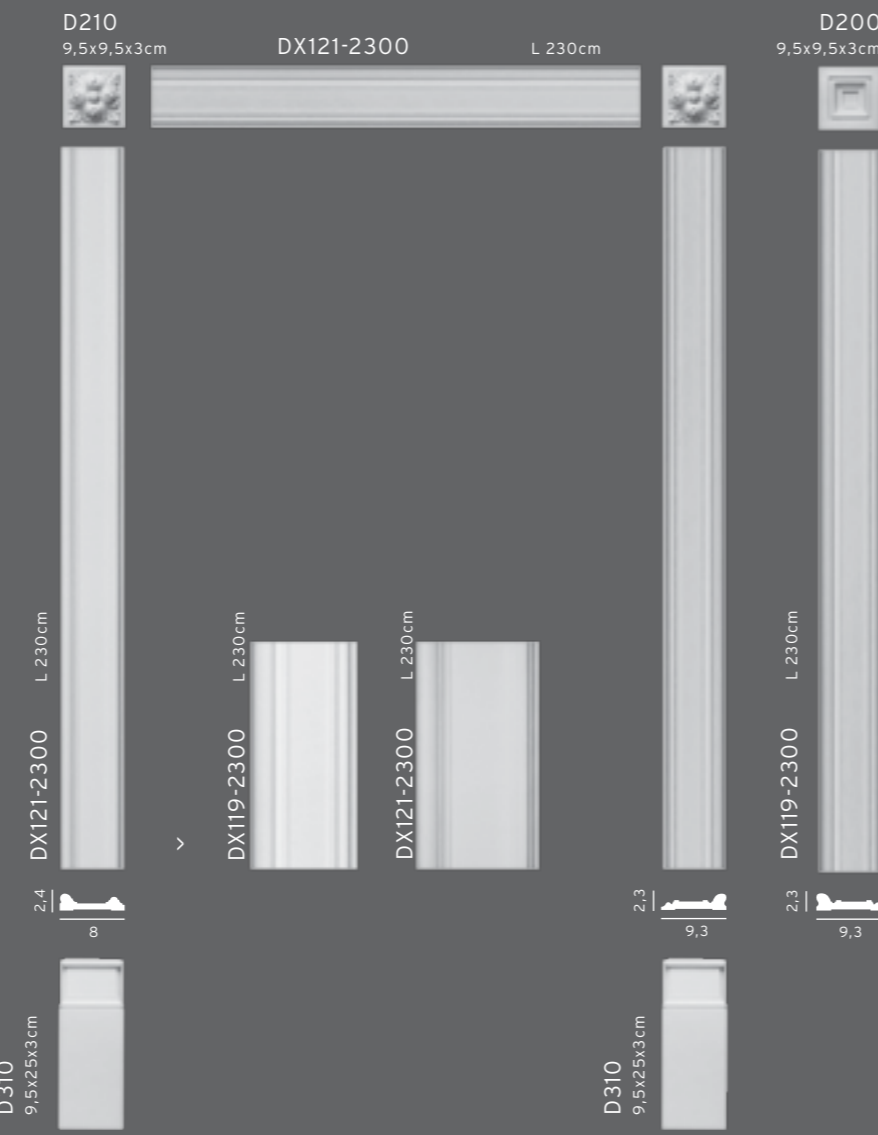
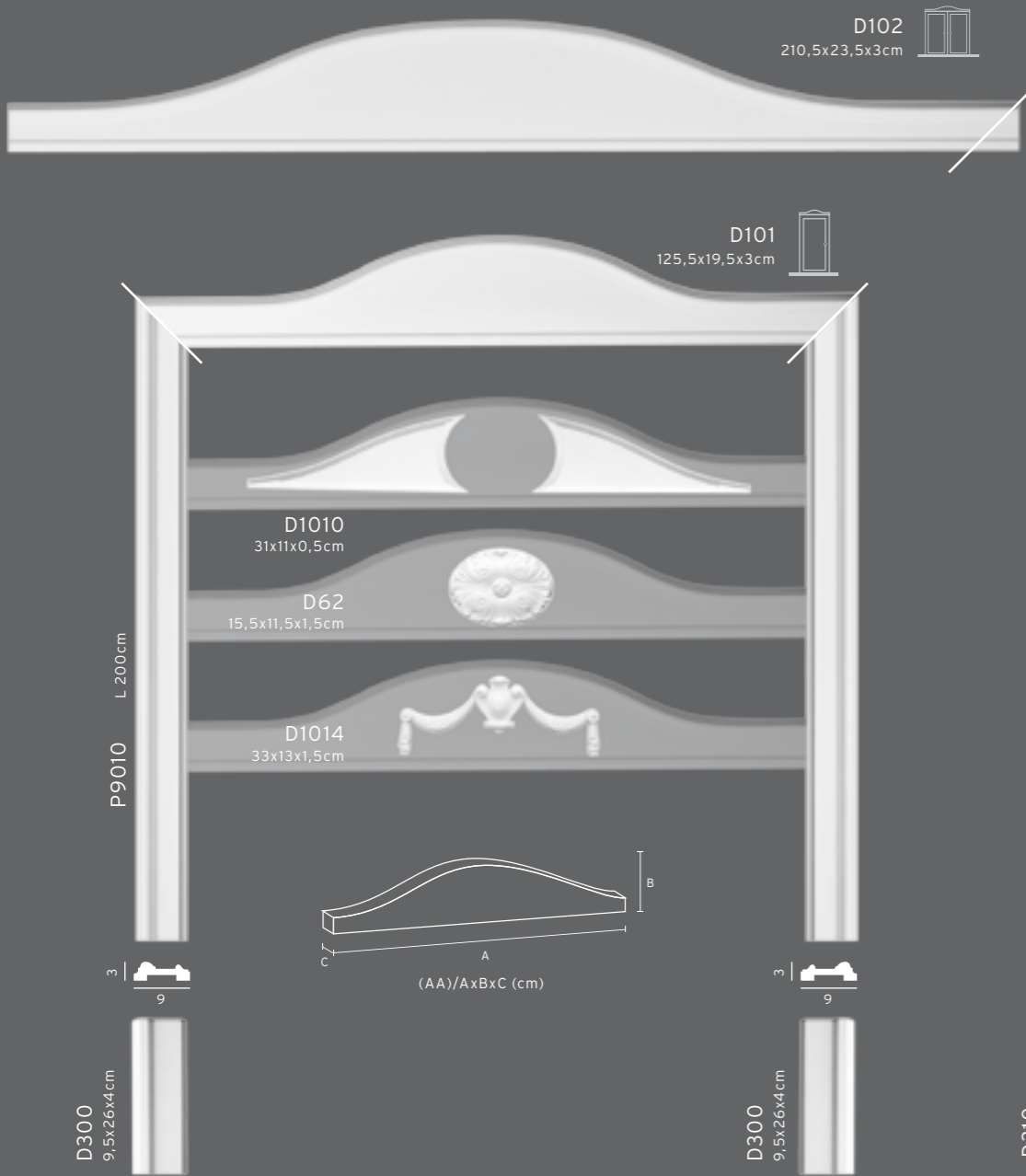

KITS

kit KX001  
 1 x DX119, L 107cm  
 2 x DX119, L 213 cm  
 2 x D200 (9,5 x 9,5 x 3 cm)

kit KX003  
 1 x DX119, L 107cm  
 2 x DX119, L 190 cm  
 2 x D200 (9,5 x 9,5 x 3 cm)  
 2 x D310 (9,5 x 25 x 3 cm)

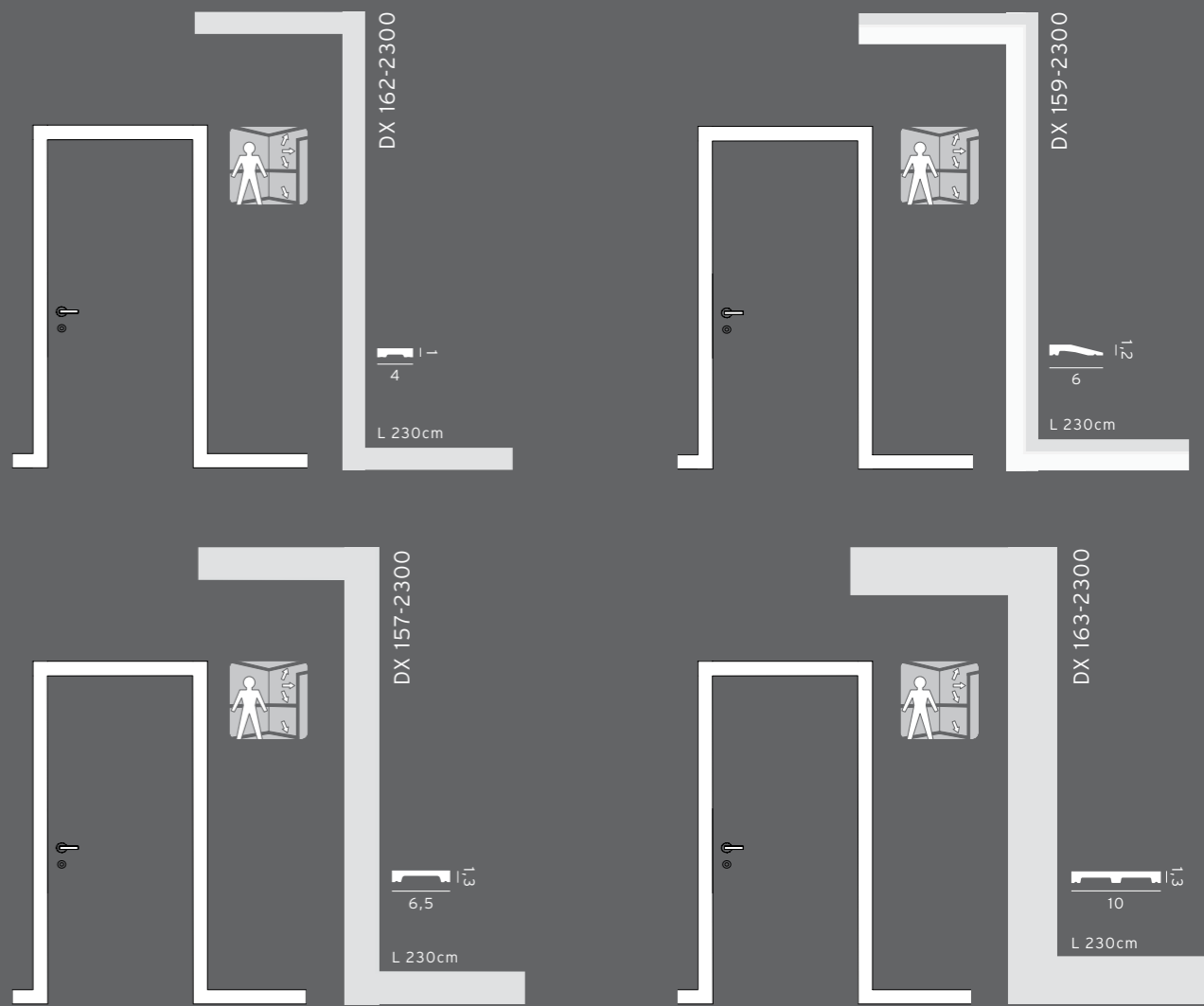



D140  
PUROTOUCH®  
99 x 32 x 2 cm

LXX



D120  
PUROTOUCH®  
124/113 x 25 x 9 cm

LXX



D402  
PUROTOUCH®  
12/7 x 14,5 x 6 cm  
(only for D400 and D401)

LXX



D400 + D402  
PUROTOUCH®  
127,5/122 x 14,5 x 5,5 cm

LXX



D150  
PUROTOUCH®  
100,5 x 15,5 x 1,5 cm

LXX



D400  
PUROTOUCH®  
127,5/122 x 14,5 x 5,5 cm

LXX



2 x D401 + D402  
PUROTOUCH®  
max. 245,5/240 x 14,5 x 5,5 cm

LXX



D161  
PUROTOUCH®  
92 x 21,5 x 4 cm

LXX



D401  
PUROTOUCH®  
127,5/122 x 14,5 x 5,5 cm

LXX



K201/L  
(H 15cm)

K201/R  
(H 15cm)

K200\* L: MAX. 200cm

\*K200 > p. 121



K200

13,5



D170  
PUROTOUCH®  
105 x 25 x 3,5 cm

LXX



M9010L, M9010A, M9010R  
D200, P9010, D300, D503, D504, SX118  
DUROPOLYMER®

LXX

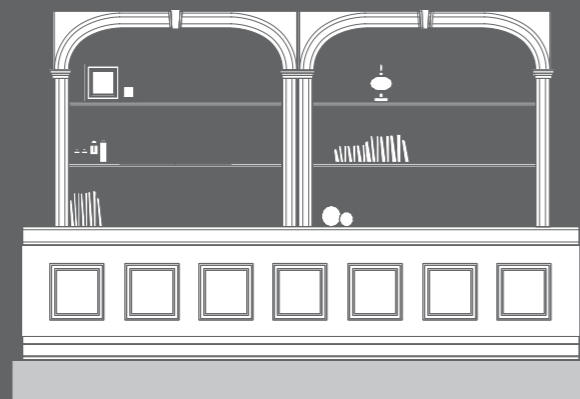

M9010L, M9010A, M9010R, M9010B, M9010C  
P9010, P9020, D506, SX105  
DUROPOLYMER®

LXX

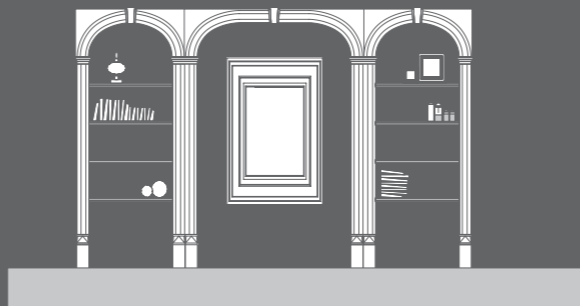

M9010L, M9010A, M9010R, M9010B, M9010C  
P9010, D300  
DUROPOLYMER®

LXX



M9010L, M9010A, M9010R  
K200, K201, D320, P9010  
DUROPOLYMER®

LXX

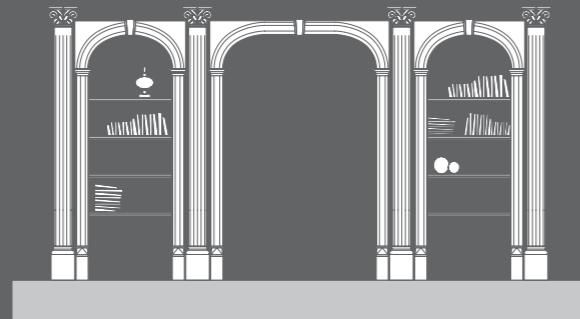

M9010L, M9010A, M9010R, M9010B, M9010C  
K201, K200, K202, P9010, D300  
DUROPOLYMER®

LXX



M9010L, M9010A, M9010R, M9010B  
P9010  
DUROPOLYMER®

LXX

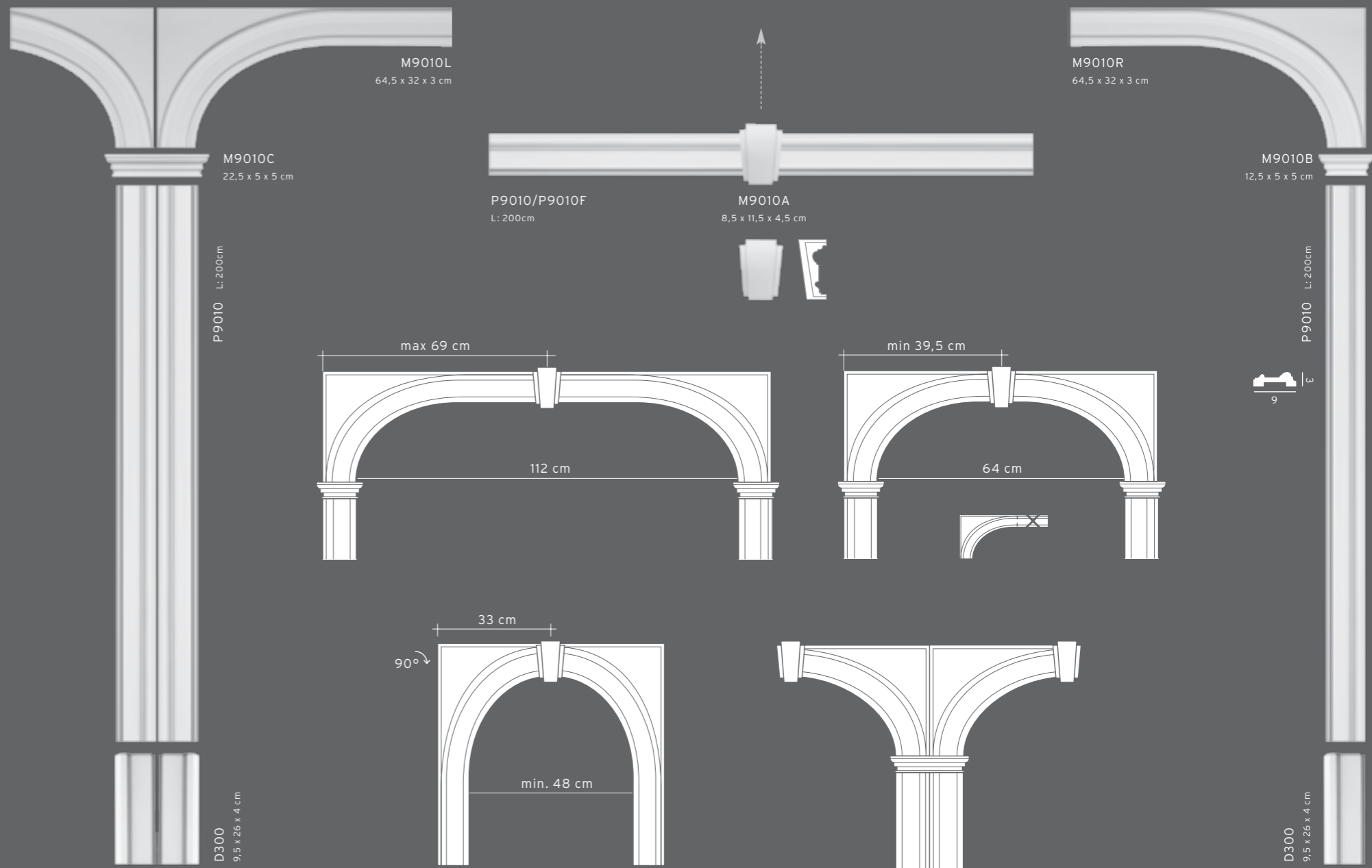





D500  
DUROPOLYMER®  
55 x 75 x 1,5 cm

LXX

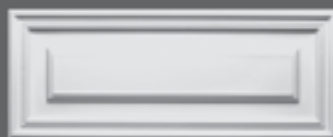

D504  
DUROPOLYMER®  
55 x 22 x 1,5 cm

LXX



D503  
DUROPOLYMER®  
55 x 55 x 1,5 cm

LXX



D507  
DUROPOLYMER®  
55 x 90,5 x 1,5 cm

LXX



D506  
DUROPOLYMER®  
43 x 43 x 1,5 cm

LXX

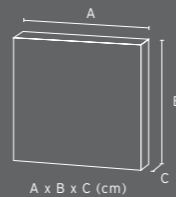

F30  
PUROTOUCH®  
60,5 x 60,5 x 4 cm

LXX



F31  
PUROTOUCH®  
59,5 x 59,5 x 6,5 cm

LXX

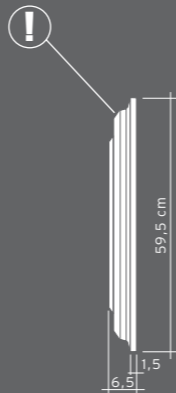

D503, D504

LXX

D507, D503, D504

LXX

DX121  
D503, D507

LXX

DX119  
D503

LXX

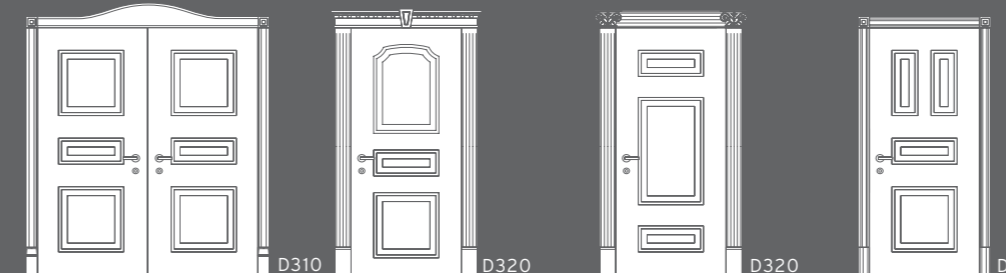

D200, D102, D503, D504

LXX

D401, D402, K200  
D500, D504, D503

LXX

K201L, K200, K201R  
D504, D507

LXX

D200, P9010, D310  
D504, D503, D507

LXX

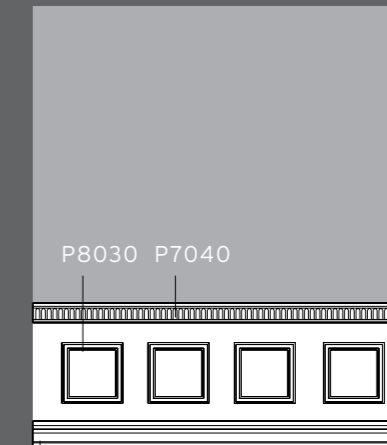

SX118  
DX121-2300

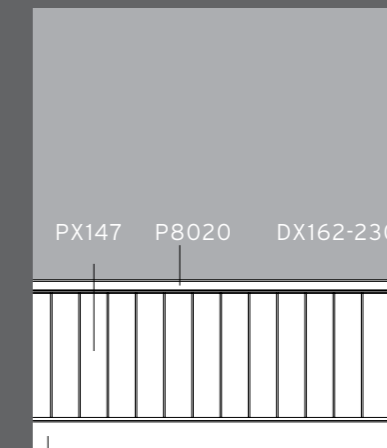

SX118

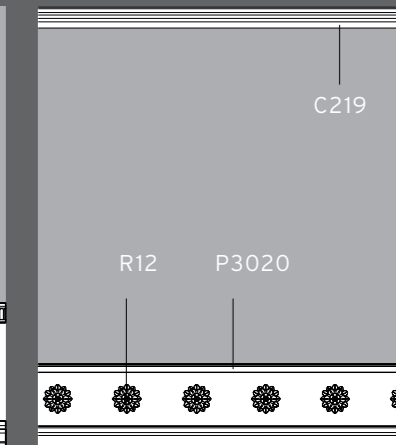

SX137

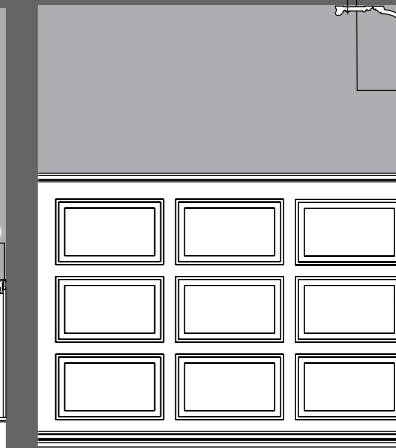

DX119-2300

C217

C200

P8020

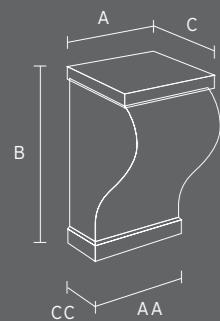

A x B x C (cm)  
AA x CC (cm)

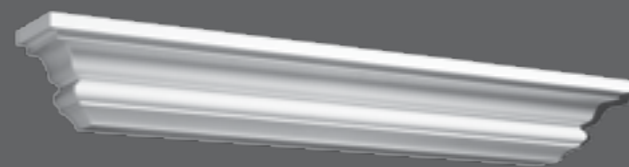

B417  
PUROTOUCH®  
90,5 x 13,5 x 14 cm

LXX



B408  
PUROTOUCH®  
22,5 x 40 x 13 cm

LXX



B404  
PUROTOUCH®  
19,5 x 31,5 x 11,5 cm

LXX



B403  
PUROTOUCH®  
19 x 19 x 10 cm

LXX



H100A

H100B

H100C



H100  
PUROTOUCH®  
114,5 x 129,5 x 20,5 cm

LXX

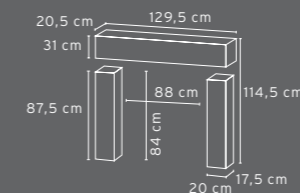

H101A

H101B

H101B



H101  
PUROTOUCH®  
110 x 129 x 20 cm

LXX

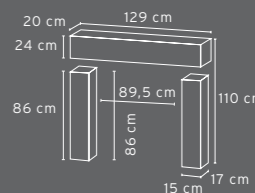

B402  
PUROTOUCH®  
9 x 22 x 7 cm

LXX



B401  
PUROTOUCH®  
11,5 x 15,5 x 7 cm

LXX



B409  
PUROTOUCH®  
30 x 35 x 17,5 cm

LXX



B413  
PUROTOUCH®  
16 x 22,5 x 8,5 cm

LXX



B414  
PUROTOUCH®  
10 x 22 x 7 cm

LXX



B410  
PUROTOUCH®  
19,5 x 50 x 16 cm

LXX



max. 2 à 3 kW

De sierschouwen zijn **enkel als decoratief element bedoeld** en mogen uitsluitend geplaatst worden in combinatie met een elektrisch vuurtje van max. 2 à 3 kW.  
Les cheminées sont **des éléments décoratifs**. Elles peuvent seulement être employées avec un feu électrique de max. 2 à 3 kW.  
The fireplaces are **just as decorative purposes** and should only be installed in conjunction with an electric heater up to 2 to 3 kW.  
Die Kamine sind **nur als Dekorative Zwecke** und sollten nur in Verbindung mit einer elektrischen Heizung bis zu 2 bis 3 kW installiert werden.  
Las chimeneas **solamente deben utilizarse como elemento decorativo**. Se puede instalar un fuego eléctrico de potencia max. 2-3 Kw.

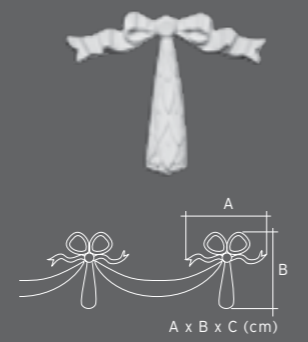

G40  
DUROPOLYMER®  
17 x 14 x 1,5 cm  
LXX



G42  
DUROPOLYMER®  
40 x 4,5 x 1,5 cm  
LXX



G50  
PUROTOUCH®  
54 x 39 x 3 cm  
LXX



G51  
PUROTOUCH®  
73,5 x 9,5 x 3 cm  
LXX



N403 / N404 / N410  
PUROTOUCH®  
N403 - 43 x 70,5 x 10 cm  
N404 - 42 x 76 x 11 cm  
N403 - 31 x 59,5 x 9,5 cm

LXX



N503 / N504 / N510 / N520  
PUROTOUCH®  
N503 - 69 x 112,5 x 11 cm  
N504 - 69 x 113 x 11 cm  
N510 - 55 x 98,5 x 18 cm  
N520 - 55 x 97,5 x 18 cm

LXX



N504 + N510  
PUROTOUCH®  
N504 - 69 x 113 x 11 cm  
N510 - 55 x 98,5 x 18 cm

LXX



N504 + N520  
PUROTOUCH®  
N504 - 69 x 113 x 11 cm  
N520 - 55 x 97,5 x 18 cm

LXX

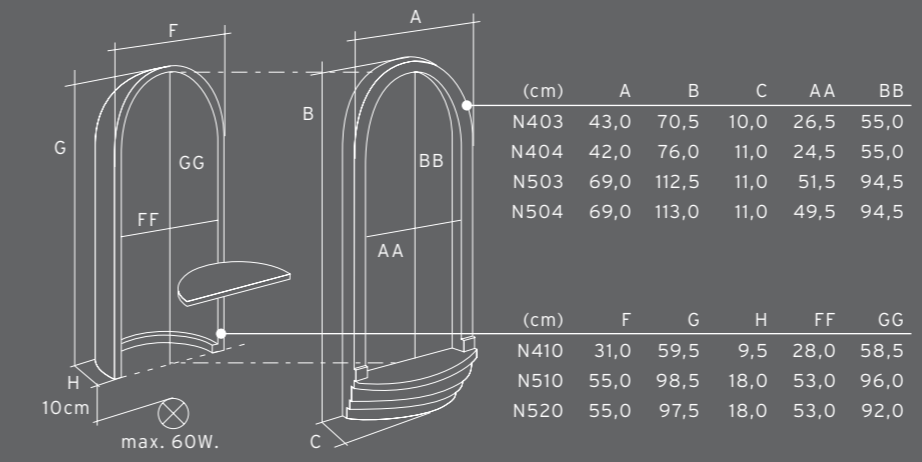

Plaats de gloeilamp (max. 60W) op min. 10cm afstand van de opale bodem.  
Installez l'ampoule (max. 60W) à 10cm minimum du fond opaque.  
Place the bulb (max. 60W) at least 10cm of soil opal.  
Legen Sie die Glühbirne (max. 60W) mindestens 10 cm des Bodens Opal.  
Instale la lámpara (max. 60W) como mínimo a 10 cms del fondo translúcido.



N503 + N510  
PUROTOUCH®  
N503 - 69 x 112,5 x 11 cm  
N510 - 55 x 98,5 x 18 cm

LXX



N503 + N520  
PUROTOUCH®  
N503 - 69 x 112,5 x 11 cm  
N520 - 55 x 97,5 x 18 cm

LXX

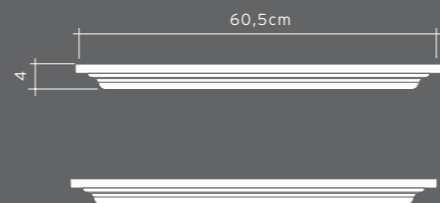

F30  
PUROTOUCH®  
60,5 x 60,5 x 4 cm\*  
\*59,5 x 59,5 x 4 cm > info@oracdecor.com

LXX

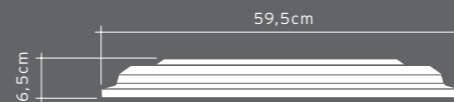

F31  
PUROTOUCH®  
59,5 x 59,5 x 6,5 cm

LXX



F10  
PUROTOUCH®  
11 x max. diam. 89,5

LXX

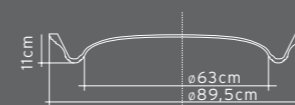

F11  
PUROTOUCH®  
9,5 x max. diam. 74,5

LXX

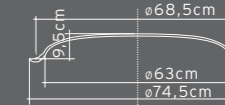

F12  
PUROTOUCH®  
33 x max. diam. 132

LXX

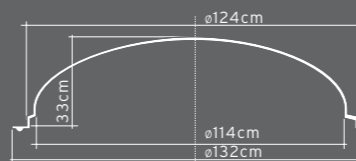

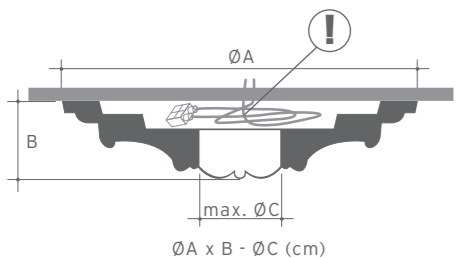

R07

PUROTOUCH®  
Ø26 x 2,5 - Ø5cm



R08

PUROTOUCH®  
Ø38 x 3,5 - Ø5cm



R09

PUROTOUCH®  
Ø48,5 x 4 - Ø6cm



R10

PUROTOUCH®  
Ø15 x 4 - Ø2cm



R11

PUROTOUCH®  
Ø19 x 4 - Ø3cm



R12

PUROTOUCH®  
Ø20 x 2 - Ø1cm



R13

PUROTOUCH®  
Ø28,5 x 3,5 - Ø2,5cm



R66

PUROTOUCH®  
Ø54,5/43 x 3,5



R76

PUROTOUCH®  
Ø62 x 4 - Ø10,5cm



R40

PUROTOUCH®  
Ø74,5 x 3,5 - Ø10cm



R35

PUROTOUCH®  
Ø22 x 3



R50

PUROTOUCH®  
Ø32 x 4 - Ø19cm



R14

PUROTOUCH®  
Ø33,5 x 3 - Ø2,5cm



R31

PUROTOUCH®  
Ø38,5 x 3 - Ø3,5cm



R61

PUROTOUCH®  
Ø40 x 2,5 - Ø2,5cm



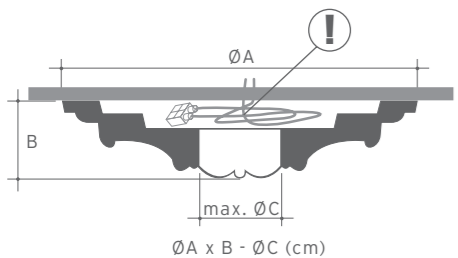

R16

PUROTOUCH®  
Ø45 x 4 - Ø3cm



R17

PUROTOUCH®  
Ø47 x 3,5 - Ø6,5cm



R18

PUROTOUCH®  
Ø49 x 5 - Ø7cm



R52

PUROTOUCH®  
Ø69,5 x 3,5 - Ø12,5cm



R38

PUROTOUCH®  
Ø71 x 4,5 - Ø19cm

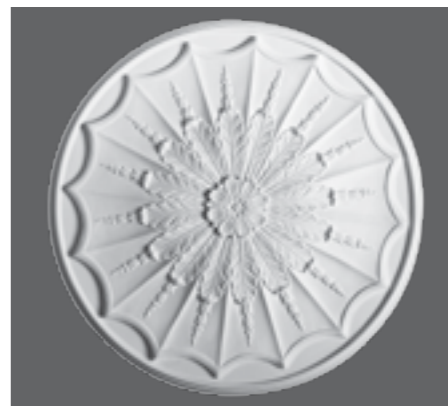

R28

PUROTOUCH®  
Ø68,5 x 3,5 - Ø2cm



R73

PUROTOUCH®  
Ø70 x 4 - Ø8cm



R46

PUROTOUCH®  
Ø53,5 x 4 - Ø3cm



R22

PUROTOUCH®  
(77 x 52,5) x 4cm



R77

PUROTOUCH®  
Ø62 x 4,5 - Ø10,5cm



R74

PUROTOUCH®  
Ø65,5 x 4 - Ø8cm



R23

PUROTOUCH®  
Ø71,5 x 4 - Ø6cm



R27

PUROTOUCH®  
Ø75 x 4,5 - Ø9cm



R24

PUROTOUCH®  
Ø79 x 4 - Ø8cm



R64

PUROTOUCH®  
Ø95,5 x 8 - Ø7cm





<p>K241 (H 16,5cm)</p>	<p>K221 (H 22cm)</p>	<p>K223 (H 22,5cm)</p>	<p>K224 (H 17cm)</p>	<p>K251 (H 35,5cm)</p>	<p>K253 (H 13,5cm)</p>	<p>K201 (H 15cm)</p>	<p>K201/L H 15cm K201/R H 15cm</p>
<p>K241</p> <p>K254</p> <p>LXX</p>	<p>K221</p> <p>K255</p> <p>LXX</p>	<p>K223</p> <p>K255</p> <p>LXX</p>	<p>K224</p> <p>K255</p> <p>LXX</p>	<p>K251</p> <p>K254</p> <p>LXX</p>	<p>K253</p> <p>K254</p> <p>LXX</p>	<p>K201</p> <p>K202</p> <p>LXX</p>	<p>K201 L/R</p> <p>D320</p> <p>LXX</p>
<p>K240 (H 200cm)</p>	<p>K220 (H 200cm)</p>	<p>K220 (H 200cm)</p>	<p>K220 (H 200cm)</p>	<p>K250 (H 200cm)</p>	<p>K250 (H 200cm)</p>	<p>K200 (H 200cm)</p>	<p>K200 (H 200cm)</p>
<p>K254 (H 53cm)</p>	<p>K255 (H 54cm)</p>	<p>K255 (H 54cm)</p>	<p>K255 (H 54cm)</p>	<p>K254 (H 53cm)</p>	<p>K254 (H 53cm)</p>	<p>K202 (H 54cm)</p>	<p>D320 (H 25cm)</p>









XL-Gesegmenteerde zuilen / XL-Colonne Segmentée / XL-Segmented columns  
XL-Säulensegmente / Columnas y medias columnas segmentadas





NL

De Orac verlichtingselementen werden volgens de hoogste standaarden op maat van de Orac profielen ontwikkeld om een optimaal lichteffect te creëren en een volledige veiligheid te garanderen. Gelieve bij gebruik van niet-Orac verlichtingssystemen rekening te houden met alle voorgeschreven richtlijnen om zo de veiligheid te waarborgen.

FR

Développés selon les normes les plus strictes, les éléments d'éclairage Orac ont été conçus spécialement pour les moulures Orac afin de garantir un effet lumineux optimal et une sécurité totale. Si vous utilisez des systèmes d'éclairage non Orac, veuillez tenir compte des prescriptions en vue de garantir la sécurité.

EN

The Orac lighting elements have been developed in accordance with the highest standards to fit the Orac profiles to create an optimal light effect and guarantee complete safety. When using non-Orac lighting systems, please observe all of the directives to ensure that safety is guaranteed.

DE

Die Orac-Beleuchtungselemente wurden den höchsten Standards entsprechend nach Maß der Orac-Profil entwickelt, um einen optimalen Lichteffekt zu erzeugen und eine uneingeschränkte Sicherheit zu garantieren. Bitte berücksichtigen Sie bei der Anwendung von Nicht-Orac-Beleuchtungssystemen sämtliche Vorschriften des Herstellers, um die Sicherheit zu gewährleisten.

ES

Cumpliendo la normativa vigente mas estricta, los sistemas de iluminación de Orac Decor han sido concebidos especialmente para las cornisas de Orac Decor con la finalidad de garantizar un efecto luminoso perfecto con la máxima seguridad. Si no se utilizan los sistemas de iluminación de Orac Decor, por favor, revisar bien las normas de seguridad del sistema empleado.



C900

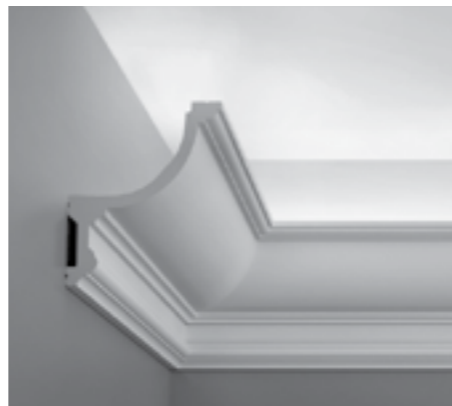
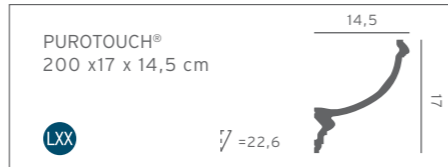

C901

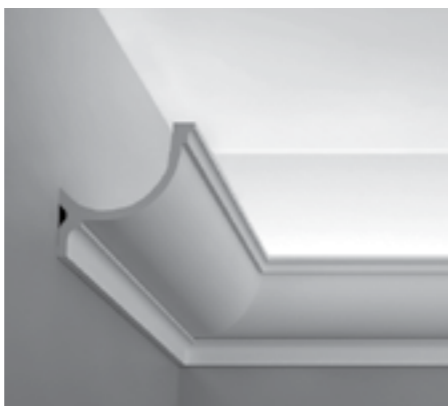
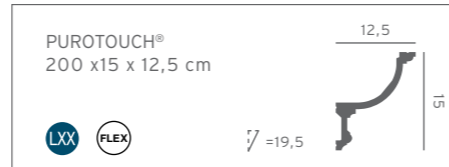

C902

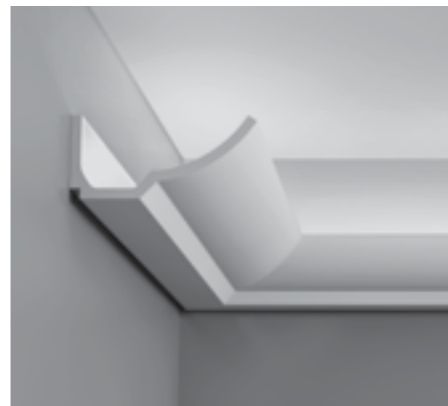
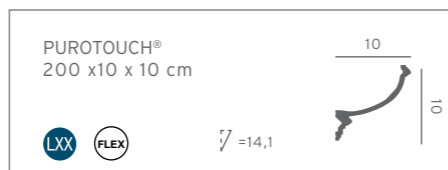

C351 - Designed by Jacques Vergracht

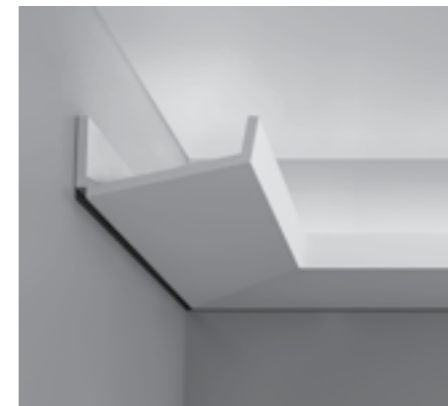
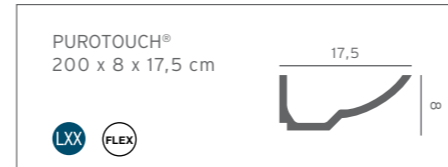

C352 - Designed by Jacques Vergracht

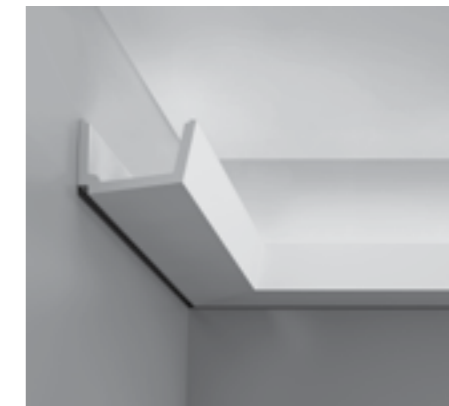

C357 - Designed by Jacques Vergracht

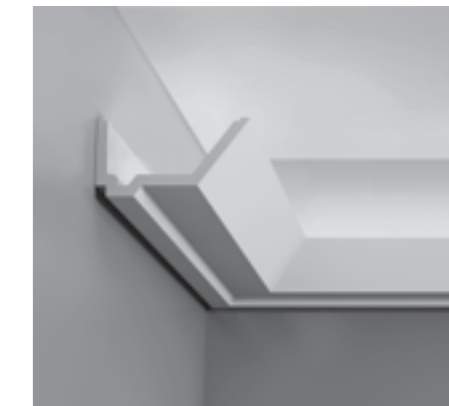
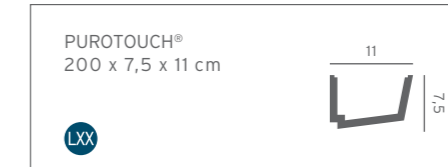

C358 - Designed by Jacques Vergracht

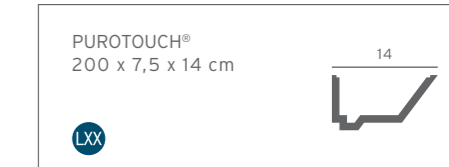

C361 - Designed by Pierre Daems

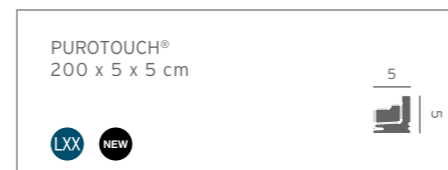

C362 - Designed by Pierre Daems

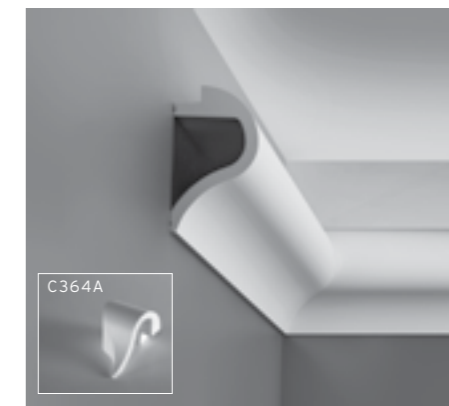
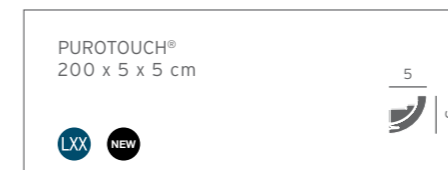

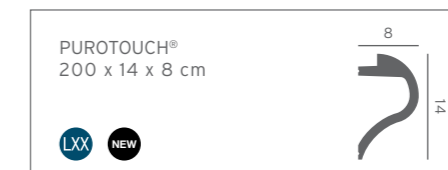

C364 - Designed by Pierre Daems

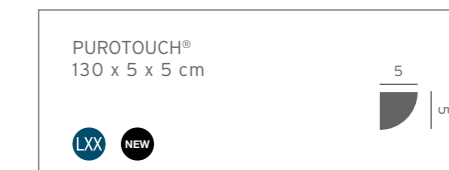

C363 - Designed by Pierre Daems



led bars

	LOW LUMEN LED BAR	HIGH LUMEN LED BAR
	IL004-001 Led bar low lumen 26x2x1,5 cm	IL004-006 Led bar high lumen 26x2x1,5 cm
	IL004-002 Led bar low lumen 114,5x2x1,5 cm	IL004-007 Led bar high lumen 114,5x2x1,5 cm
IP CLASS	IP50	IP50
VOLTAGE	24 V	24 V
COLOUR TEMPERATURE	WARM WHITE	WARM WHITE
LIGHT OUTPUT / METER	+/- 100 LM/M	+/- 500 LM/M
LIFE SPAN (AVGE LUMEN MAINTENANCE)	30 000 HOURS	30 000 HOURS
POWER	+/- 4 W/M	+/- 10,5 W/M
 MAXIMUM LENGTH OF LED BARS CONNECTED TO A DRIVER (60 W)	12 M	6 M
 MAXIMUM CABLE LENGTH FROM DRIVER TO LED BAR CONNECTOR	5 M	5 M

led connecting cable / led driver

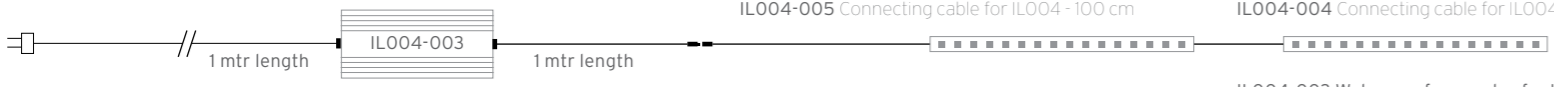
	IL004-003	IL004-004
	IL004-003 Waterproof convertor for IL004 (60W) - 15x6,8x5 cm	IL004-004 Connecting cable for IL004 - 12,5 cm
IP CLASS	IP67	
POWER	60 W	
INPUT VOLTAGE	240 VAC, MAX. 300 MA	
OUTPUT	24 VDC, MAX. 2500 MA	

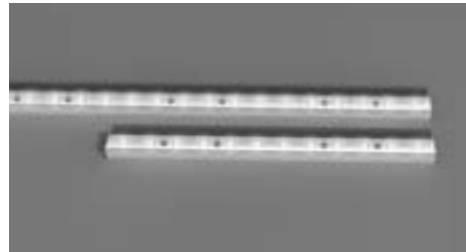

IL004-001 + IL004-002

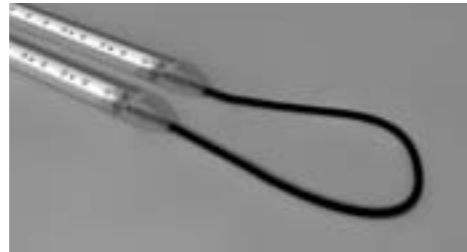



IL004-004

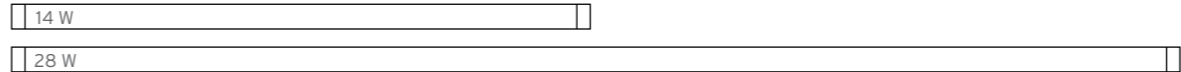

IL004-003 + IL004-005

T5 tube

	T5 TUBE 1X14W	T5 TUBE 1X28W
	IL002-001 T5 tube fixture incl. T5 tube HE 59 cm	IL002-002 T5 tube fixture incl. T5 tube HE 119 cm
IP CLASS	IP44	IP44
VOLTAGE	230 V	230 V
COLOUR TEMPERATURE	2700 K WARM WHITE	2700 K WARM WHITE
LIGHT OUTPUT / METER	1350 LM/M	2900 LM/M
POWER	14 W	28 W
 MAXIMUM QUANTITY OF T5 FIXTURES TO BE CONNECTED	12	

T5 tube power feed

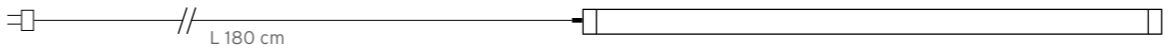
	IL002-003 L 180CM
	
TYPE	power feed



T5 tube (14W + 28W) + IL002-003

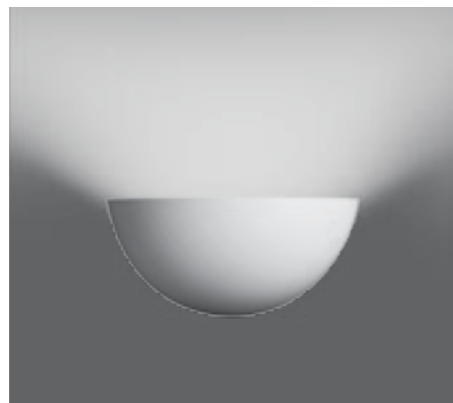
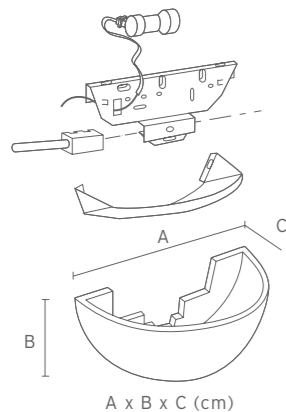

L504

DUROPOLYMER®  
30,5 x 15 x 15 cm

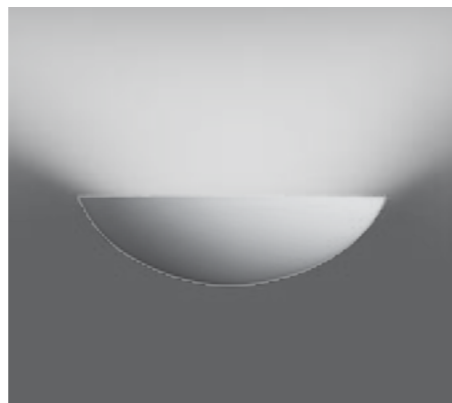

L505

DUROPOLYMER®  
41 x 11,5 x 16,5 cm

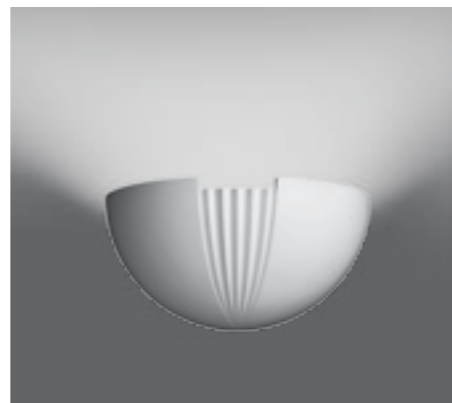

L509

DUROPOLYMER®  
29 x 17 x 14,5 cm



L600-001 XINNIX

19,5 x 8,5 x 34 cm

Inbouwarmatuur voor spaarlamp (18W - G24 - q2) > zie p. 21  
 luminaire encastrée pour lampe économique (18W - G24 - q2) > voir p. 21  
 Recessed fixture for energy saving lamp (18W - G24 - q2) > see p. 21  
 Einbauarmatur für Sparlampen (18W - G24 - q2) > siehe S. 21  
 Aplique para encastrar en la pared para lámpara de bajo consumo (18W - G24 - q2) > see p. 21



L601-001 XINNIX

10 x 9 x 10 cm

Inbouwarmatuur voor MycroLynx F7W (wit & kleur) of MycroLynx LED (wit & kleur)  
 Luminaire encastrée pour MycroLynx F7W (en blanc et en couleur) ou MycroLynx LED (en blanc et en couleur)  
 Recessed fixture for MycroLynx F7W (white & color) or MycroLynx LED (white & color)  
 Einbauarmatur für MycroLynx F7W (weiss oder in Farbe) oder MycroLynx LED (weiss oder in Farbe)  
 Aplique para encastrar en la pared para lámpara MycroLynx F7W (blanco o de color) o LED MycroLynx (blanco o de color)



IL003-011 LED INSERT

4 x 0,9 x 4,6 cm

Set van 5 LED's (1 LED = 0,2W) + verlengkabels (5x1m)  
 Het is mogelijk 1 LED lamp te vervangen  
 Set de 5 LED's (1 LED = 0,2W) + câbles d'extension (5x1m)  
 Possibilité de changer une lampe LED  
 Set of 5 LED's (1 LED = 0,2W) + 5 extension cables (5x1m)  
 Possible to replace a single LED lamp  
 Set mit 5 LED's (1 LED = 0,2W) + Verlängerungskabel (5x1m)  
 Wechsel der LED-Lampen möglich  
 Conjunto de 5 LED's (1 LED = 0,2W) + cables de extensión (5x1m)  
 Posibilidad de cambiar una lámpara LED

IL003-012 TRANSFO

6 x 3,5 x 2 cm

Transformator max. 20 lampjes  
 Converteur de puissance max. 20 lampes  
 Converter max. 20 lamps  
 Trafo für max. 20 Lampen  
 Transformador max. 20 lámparas

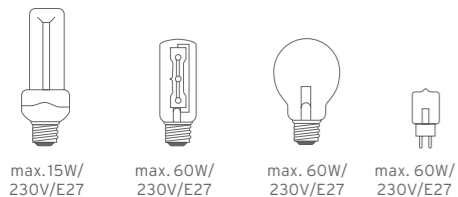

L512

DUROPOLYMER®  
30,5 x 12,5 x 15,5 cm

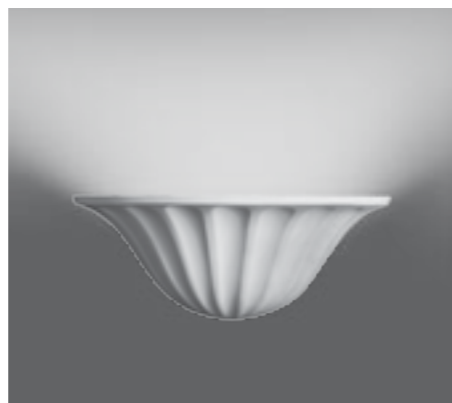

L506

DUROPOLYMER®  
39 x 15,5 x 19 cm



L501

DUROPOLYMER®  
35 x 22 x 16 cm

Lampjes worden niet door ORAC verkocht / Les ampoules ne sont pas fournies par ORAC / Lightbulbs not supplied by Orac / Lampen werden von Orac nicht mitgeliefert / Las lámparas no son fabricadas por Orac

NL

# Lijmen

**BINNEN, POREUZE EN DROGE ONDERGRONDEN**

Lijmen op wanden en plafonds

Naden

Voor Basixx: gebruik DecoFix Pro voor de naden

	DecoFix Pro FDP500 310ml > 7 tot 8m FDP600 4200ml > 65 tot 110m	<ul style="list-style-type: none"> <li>• Sterke acryllijm op waterbasis</li> <li>• Langdurende verbinding tussen profielen en muur en/of plafond</li> <li>• Voor binnentoepassingen op poreuze ondergronden (niet in vochtige ruimtes en buiten)</li> <li>• Verwijder met een vochtige spons of doek</li> <li>• Vorstvrij bewaren</li> </ul>
--	---	--

**BUITEN, NIET-POREUZE EN VOCHTIGE ONDERGRONDEN**

Lijmen op wanden en plafonds

Naden

Voor gebruik voor de naden

	DecoFix Extra FX200 310ml > min. 80m FX210 80ml > min. 20m	<ul style="list-style-type: none"> <li>• Lijm op polyurethaanbasis</li> <li>• Voor naadverbindingen tussen profielen</li> <li>• Verwijder de overtollige lijm vóór uitharding (herhaal na max. 1 uur en na 2 tot 3 uur)</li> <li>• Maak schoon met aceton of synthetische verdunner</li> <li>• Overschilderbaar na 24 uur</li> <li>• Hoe hoger de vochtigheidsgraad, hoe sneller de droogtijd</li> </ul>
--	--	--

	DecoFix Hydro FDP700 290 ml > 7 tot 8 m	<ul style="list-style-type: none"> <li>• Extra sterke MS-polymeerlijm</li> <li>• Voor buitentoepassingen, in vochtige ruimtes en op niet-poreuze ondergronden (tegels, glas, ...)</li> <li>• Verwijder met een zeepoplossing</li> </ul>
--	--	---

**VOLLEDIGE GARANTIE ENKEL BIJ GEBRUIK VAN DECOFIX**

FR

# Colles

**SURFACES POREUSES, PIÈCES NON HUMIDES**

Collage sur mur et plafond

Joints

Pour Basixx utilisez DecoFix Pro pour les joints

	DecoFix Pro FDP500 310ml > 7 à 8m FDP600 4200ml > 65 à 110m	<ul style="list-style-type: none"> <li>• Colle forte à base d'eau et d'acrylique</li> <li>• Joint longue durée entre les moulures et le mur et/ou le plafond</li> <li>• Pour les applications intérieures et les surfaces poreuses (hors environnement humide ou extérieur)</li> <li>• Retirez à l'aide d'une éponge ou d'un chiffon humide</li> <li>• Doit être conservée à l'abri du gel</li> </ul>
--	---	---

**ENVIRONNEMENT HUMIDE, SURFACES NON POREUSES, POSE À L'EXTÉRIEUR**

Collage sur mur et plafond

Joints

Pour Basixx utilisez DecoFix Pro pour les joints

	DecoFix Extra FX200 310ml > min. 80m FX210 80ml > min. 20m	<ul style="list-style-type: none"> <li>• Colle polyuréthane</li> <li>• Pour l'assemblage des joints entre les moulures</li> <li>• Éliminez les excès de colle avant le durcissement (1 heure max. et recommencez après 2-3 heures)</li> <li>• Nettoyez avec de l'acétone ou un diluant synthétique</li> <li>• Peut être peint après 24 h</li> <li>• Humidité est importante</li> </ul>
--	--	--

	DecoFix Hydro FDP700 290 ml > 7 à 8 m	<ul style="list-style-type: none"> <li>• Colle au MS polymère extra forte</li> <li>• Pour les applications extérieures, les environnements humides, les surfaces non poreuses (carrelage, verre, etc.)</li> <li>• Enlevez à l'aide d'une solution savonneuse</li> </ul>
--	--	---

**GARANTIE TOTALE UNIQUEMENT AVEC COLLE DECOFIX**

EN

# Glues

**INTERIOR, POROUS AND DRY SURFACE**

Gluing on wall and ceiling

Joints

For Basixx use DecoFix Pro for joints

	DecoFix Pro FDP500 310ml > 7 to 8m FDP600 4200ml > 65 to 110m	<ul style="list-style-type: none"> <li>• Strong, water-based acrylic glue</li> <li>• Long-lasting seal between mouldings and the wall and/or ceiling</li> <li>• For interior applications and porous surfaces (not for humid spaces or outside)</li> <li>• Remove with humid sponge or cloth</li> <li>• Should be kept frost free</li> </ul>
--	---	--

**EXTERIOR, NON-POROUS AND HUMID SURFACE**

Gluing on wall and ceiling

Joints

For Basixx use DecoFix Pro for joints

	DecoFix Extra FX200 310ml > min. 80m FX210 80ml > min. 20m	<ul style="list-style-type: none"> <li>• Polyurethane-based glue</li> <li>• Seam joints between the mouldings</li> <li>• Remove excess glue before hardening (max. 1 hour and repeat after 2-3 hours)</li> <li>• Clean with acetone or Synth Thinner</li> <li>• Can be painted after 24 hrs</li> <li>• The more humidity, the faster the drying time</li> </ul>
--	--	---

	DecoFix Hydro FDP700 290 ml > 7 to 8 m	<ul style="list-style-type: none"> <li>• Extra strong MS polymer glue</li> <li>• For exterior applications, damp environments, non-porous surfaces (tiles, glass, ...)</li> <li>• Remove with soap solution</li> </ul>
--	---	--

**ONLY FULL GUARANTEE WITH DECOFIX**

DE

# Kleber

**INNEN, PORÖSE/SAUGFÄHIGER UND TROCKENE UNTERGRÜNDE**

Kleben an Wand und Decke

Stoßstellen

Für Basixx Verwenden Sie DecoFix Pro für die Stoßstellen

	DecoFix Pro FDP500 310ml > 7 bis 8m FDP600 4200ml > 65 bis 110m	<ul style="list-style-type: none"> <li>• Starker, wasserbasierter Acrylkleber</li> <li>• Langhaltende Verbindung zwischen Profilen und Wand und/oder Decke</li> <li>• Für Innenanwendungen auf porösen/saugfähigen Untergründen (nicht in Feuchträumen und Außenbereichen)</li> <li>• Mit wenig feuchtem Schwamm oder Tuch entfernen</li> <li>• Frostfrei lagern</li> </ul>
--	---	---

**AUSSEN, NICHT-PORÖSER/SAUGFÄHIGER UNTERGRUND UND FEUCHTRÄUME**

Kleben an Wand und Decke

Stoßstellen

Für Basixx Verwenden Sie DecoFix Pro für die Stoßstellen

	DecoFix Extra FX200 310ml > min. 80m FX210 80ml > min. 20m	<ul style="list-style-type: none"> <li>• Polyurethanbasierter Kleber</li> <li>• Für Nahtverbindungen zwischen Profilen</li> <li>• Überschüssigen Kleber vor dem Aushärten entfernen (nach 1 Std und nach 2 - 3 Std wiederholen)</li> <li>• Mit Aceton oder synthetischem Verdünner reinigen</li> <li>• nach 24 Std überstrichbar</li> <li>• Je höher die Luftfeuchtigkeit, desto kürzer die Trockenzeit</li> </ul>
--	--	--

	DecoFix Hydro FDP700 290 ml > 7 bis 8 m	<ul style="list-style-type: none"> <li>• Besonders starker MS-Polymerkleber</li> <li>• Für Außenanwendungen, in Feuchträumen und auf nicht porösem/saugfähigem Untergrund (Fliesen, Glas,...)</li> <li>• Mit Seifenlösung entfernen</li> </ul>
--	--	--

**VOLLSTÄNDIGE GARANTIE NUR BEI DER VERWENDUNG VON DECOFIX**

ES

# Colas

**INTERIOR, SUPERFICIES SECAS Y POROSAS**

Encolar al techo y la pared

Uniones entre piezas

Para Orac Basixx utilize DecoFix Pro para las uniones entre piezas

	DecoFix Pro FDP500 310ml > 7 a 8m FDP600 4200ml	<ul style="list-style-type: none"> <li>• Cola / masilla</li> <li>• Fuerte, cola acrílica con base de agua</li> <li>• Larga adherencia con nuestras masillas en techos y paredes</li> <li>• Para aplicaciones al interior y superficies porosas no para espacio húmedos (o aplicaciones al exterior).</li> <li>• Eliminar con una esponja o paño húmedo</li> <li>• Debe guardarse en un ambiente seco</li> </ul>
--	---	---

**EXTERIOR, AMBIENTES HÚMEDOS E INSTALACIONES EN SUPERFICIES NO POROSAS**

Encolar al techo y la pared

Uniones entre piezas

Para Orac Basixx utilize DecoFix Pro para las uniones entre piezas

	DecoFix Extra FX200 310ml > min. 80m FX210 80ml > min. 20m	<ul style="list-style-type: none"> <li>• Cola sólo uniones (Basixx no)</li> <li>• Cola a base de Poliuretano</li> <li>• Sellar las uniones entre las molduras</li> <li>• Eliminar cola excesiva antes de endurecer (max. 1 hora y repetir 2-3 horas después)</li> <li>• Limpiar con acetona o disolvente sintético</li> <li>• Puede pintarse después de 24 horas</li> <li>• Cuanta más humedad, más rápida la duración de secado</li> </ul>
--	--	---

	DecoFix Hydro FDP700 290 ml > 7 a 8 m	<ul style="list-style-type: none"> <li>• Cola / masilla</li> <li>• Extra fuerte, cola a base de Poliuretano</li> <li>• Para aplicaciones al exterior, lugares húmedos, superficies no porosas (cerámica, vidrio,...)</li> <li>• Eliminar con agua y jabón</li> </ul>
--	--	--

**GARANTÍA COMPLETA SÓLO SI SE UTILIZA DECOFIX**



Inside corner | Binnenhoek | Coin intérieur | Innenecke | Esquina interna

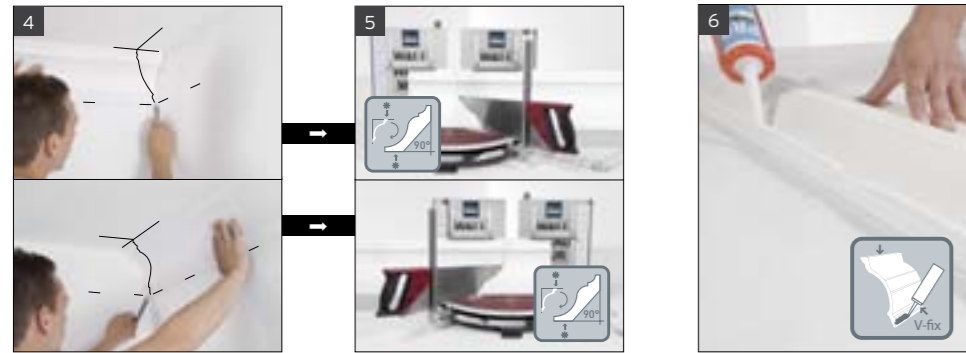

Outside corner | Buitenhoek  
Coin extérieur | Aussenecke  
Esquina externa

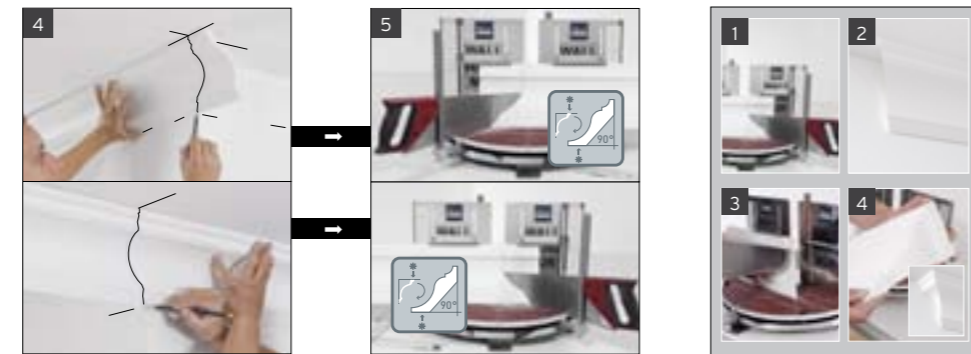

Stop mitre | Stopverstek  
Couper en onglets |  
Auf Gehrung schneiden  
Ingletadora

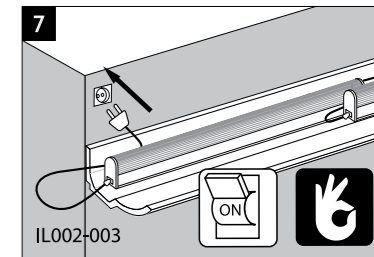
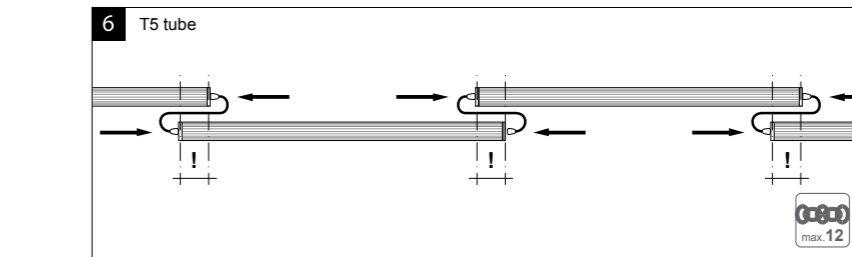
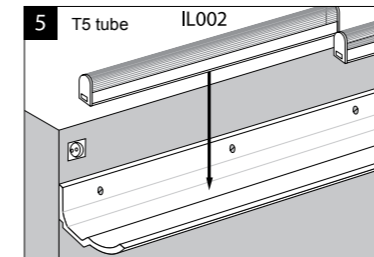
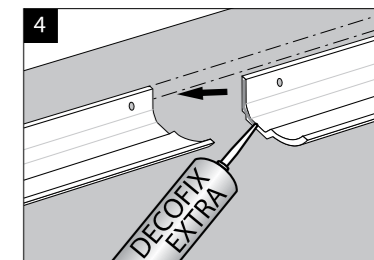
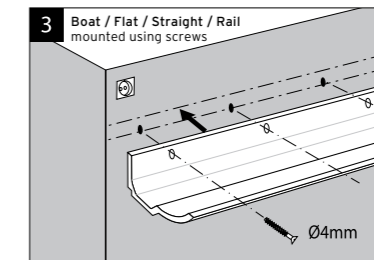
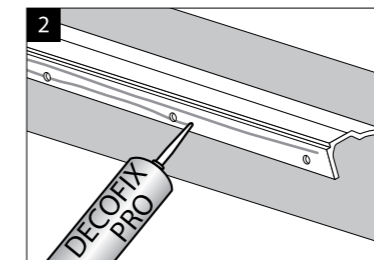
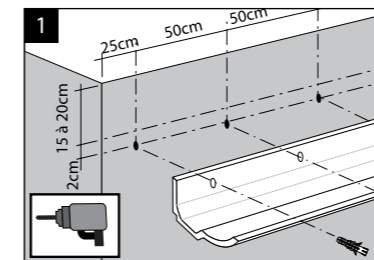
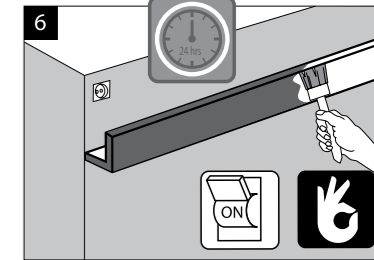
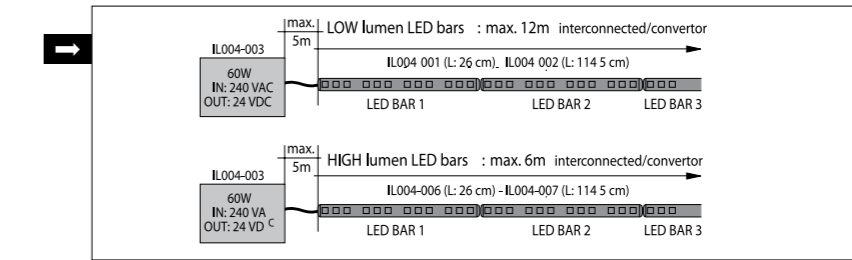
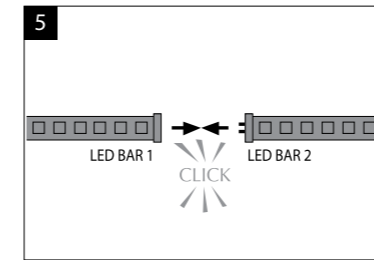
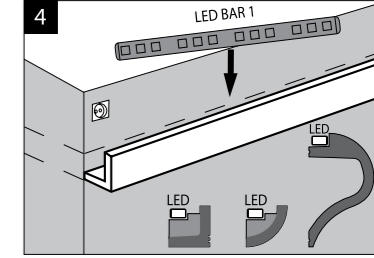
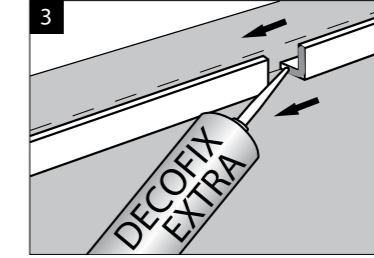
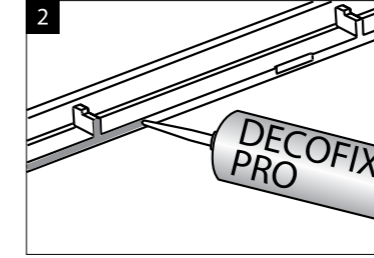
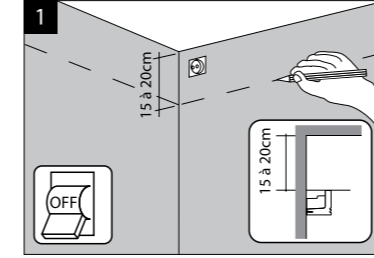





ORAC DECOR XXL 1 CASE  
MS046-001 LX AX XX



ORAC DECOR XXL 2 CASE  
MS046-002 LX AX



ORAC DECOR XXL 3 CASE  
MS046-003 LX



ORAC DECOR MEDIUM 1 CASE  
A45 AX XX



ORAC DECOR MEDIUM 2 CASE  
A45-002 AX LX



ORAC DECOR  
DISPLAY LUXXUS Collection MD016-001

ALSO AVAILABLE:  
DISPLAY AXSENT Collection MD016-002  
DISPLAY BASIXX Collection MD017-002



ORAC DECOR SKIRTING BOX  
MS008-001



ORAC DECOR ARCHIBOX  
MS010-002



ORAC DECOR WALL + SAMPLE SLIDE SYSTEM  
MD013-405

'Also available without sample slide system' MD013-005



ORAC DECOR CORNER - WITHOUT SAMPLE SLIDE SYSTEM  
MD013-006

'Also available with sample slides system' MD013-406



ORAC DECOR TOWER MEDIUM  
MD013-019

NL

**BUITENTOEPASSINGEN**

Zowel de Orac Luxxus als de Orac Axxent producten zijn geschikt voor buiten en in vochtige ruimtes. Voor de verlijming gaat u hetzelfde te werk als bij binnentoepassingen, maar u vervangt de DecoFix Pro door de DecoFix Hydro. Deze producten dienen met een kwalitatieve buitenverf overschilderd te worden.

**BINNENINSTALLATIE HARDE KROONLIJSTEN**

Garantievoorwaarden gelden enkel bij volledige naleving van de installatieinstructies.

**GARANTIE**

ORAC DECOR® ornamenten zijn onbreekbaar, licht en gemakkelijk te installeren. Ze worden verwerkt als licht hout en afgewerkt met kwaliteitsverven. Controleer de afmetingen van de ornamenten op de werkplaats vooraleer te installeren. Maatwijzigingen en afwijkingen ten opzichte van deze catalogus voorbehouden. Contacteer ons gerust voor verdere inlichtingen. Alle technische informatie vindt u terug op [www.oracdecor.com](http://www.oracdecor.com). Garantievoorwaarden gelden enkel bij volledige naleving van deze instructies.

**BRANDVOORSCHRIFTEN**

In veel interieurs of projecten zijn strikte brandvoorschriften opgelegd. Orac heeft daarvoor verschillende oplossingen, afhankelijk van het land en zijn reglementeringen. Contacteer ons 'engineering department' voor een specifiek verzoek.

FR

**APPLICATIONS EXTÉRIEURES**

Tant les produits Orac Luxxus que les produits Orac Axxent conviennent pour l'extérieur et les endroits humides. Pour encoller ces produits, vous procédez de la même façon que pour les applications à l'intérieur, mais vous remplacez la DecoFix Pro par la DecoFix Hydro. Ces produits doivent être parachevés avec une peinture spéciale pour extérieur.

**INSTALLATION DE CORNICHES DURES DANS UN INTÉRIEUR**

Les conditions de garantie sont uniquement valables en cas d'observation complète des instructions de pose.

**GARANTIE**

Les ornements ORAC DECOR® sont incassables, légers et faciles à installer. Ils sont utilisés comme du bois léger et parachevés avec des peintures de qualité. Contrôlez les dimensions des ornements dans la pièce où ils doivent être installés, avant de procéder à l'installation, sous réserve de modifications et de discordances avec les mesures indiquées dans ce catalogue. N'hésitez pas à nous contacter pour obtenir de plus amples informations.

Vous trouverez toutes les informations techniques sur [www.oracdecor.com](http://www.oracdecor.com). Les conditions de garantie ne sont d'application que si ces instructions ont été suivies à la lettre.

**NORMES ANTI-INCENDIE**

Pour beaucoup d'intérieurs et de projets, les exigences en terme de prévention incendie sont très strictes. C'est pour cette raison qu'Orac propose quelques produits répondant aux standards anti-feu et élabore des solutions adaptées aux exigences de votre projet. Contactez nous pour plus d'information.

EN

**EXTERIOR APPLICATIONS**

All Orac Luxxus as well as the Orac Axxent products can be used for exterior applications and in damp environments. To glue the ornaments, you proceed exactly as for interior applications, but you replace the DecoFix Pro adhesive product with DecoFix Hydro. The products have to be covered with a special coating for outside use.

**GUARANTEE**

ORAC DECOR® ornaments are unbreakable, light and easy to install. They are processed in the same way as light wood and finished with a quality primer. You will find all the technical information on our website [www.oracdecor.com](http://www.oracdecor.com). Guarantee terms and conditions apply if provided instructions have been followed to the letter. Check the measurements of the ornaments on the premises before you start installing them, there may be some discrepancies in sizes or/and shapes against those stated in the catalogue. Do not hesitate to call for any further information you may require.

**FIRE RETARDANT STANDARDS**

In many interiors and projects strict fire regulations are imposed. Therefore, ORAC has implemented a number of solutions depending on the country and its regulations. Please contact our engineering department for more detailed requests.

DE

**INNENMONTAGE VON ECKLEISTEN**

Die Garantie ist nur gültig bei einer Installation gemäß der Montagehinweise.

**AUßENVERARBEITUNG**

Alle Orac Luxus und Orac Axxent Artikel eignen sich, unter Einhaltung der Verarbeitungsrichtlinien, für die Verwendung im Außenbereich und Feuchträumen (Schwimmbad, Sauna, etc.). Für Außenarbeiten und Feuchträume zur Montage DecoFix Hydro anstelle von DecoFix Pro verwenden. Die Produkte müssen mit einer speziellen Fassadenfarbe versehen werden.

**GARANTIE**

Alle ORAC DECOR®-Profile sind im Gegensatz zu Stuck aus Gips oder Holz leicht, sehr widerstands-fähig und einfach zu installieren. Qualitätsfarben, gleich ob Lack, Dispersion oder Lasuren, werden hervorragend angenommen. Alle Technische Information finden Sie auf [www.oracdecor.com](http://www.oracdecor.com). Die Garantie ist nur gültig bei einer Installation gemäß der Montagehinweise. Kontrollieren Sie vor der Montage die Maße und Beschaffenheit der Ware. Wir behalten uns das Recht vor, Produktänderungen, die ausschließlich der Verbesserung des Artikels dienen, den Vertragszweck nicht gefährden und zumutbar sind, ohne Vorankündigung durchzuführen. Wir geben Ihnen gerne telefonisch weitere Auskünfte.

**BRANDVORSCHRIFTEN**

Für viele Interieure und Projekte gelten sehr strenge Richtlinien. Folglich hat Orac, unter Berücksichtigung der jeweils gültigen Normen in unseren Exportländern, eine Reihe von Lösungen ausgearbeitet. Für ausführliche Informationen kontaktieren Sie uns

ES

**INSTALACIÓN DE CORNISAS RIGIDAS EN EL INTERIOR**

La garantía será efectiva siempre que se sigan las instrucciones de montaje.

**APLICACIONES PARA EXTERIOR**

Toda la gama Orac Luxus y Orac Axxent pueden ser utilizadas en el exterior o en ambientes húmedos. Para encolar los productos se hará de la misma manera que en el interior pero sustituyendo la cola DecoFix Pro por la DecoFix Hydro. Los productos tienen que ser pintados con pintura para exterior.

**GARANTÍA Y NORMAS IGNIFUGAS**

Los ornamentos ORAC DECOR® son resistentes, ligeros y fáciles de instalar. Puede encontrar toda la información técnica en [www.oracdecor.com](http://www.oracdecor.com). La garantía no será efectiva si no se siguen las instrucciones de instalación.

Verificar las medidas de los ornamentos antes de empezar la instalación. Puede haber alguna diferencia de tamaño o forma respecto al catálogo. No duden en contactarnos para más información.

**NORMAS IGNIFUGAS**

Para muchos proyectos de interior la normativa anti-fuego son muy estrictas. Por este motivo Orac propone varias soluciones en función de las exigencias de cada país. Por favor, no dude en contactarnos para ofrecerle una información más detallada.



DX162-2300



DX162-2300



DX162-2300

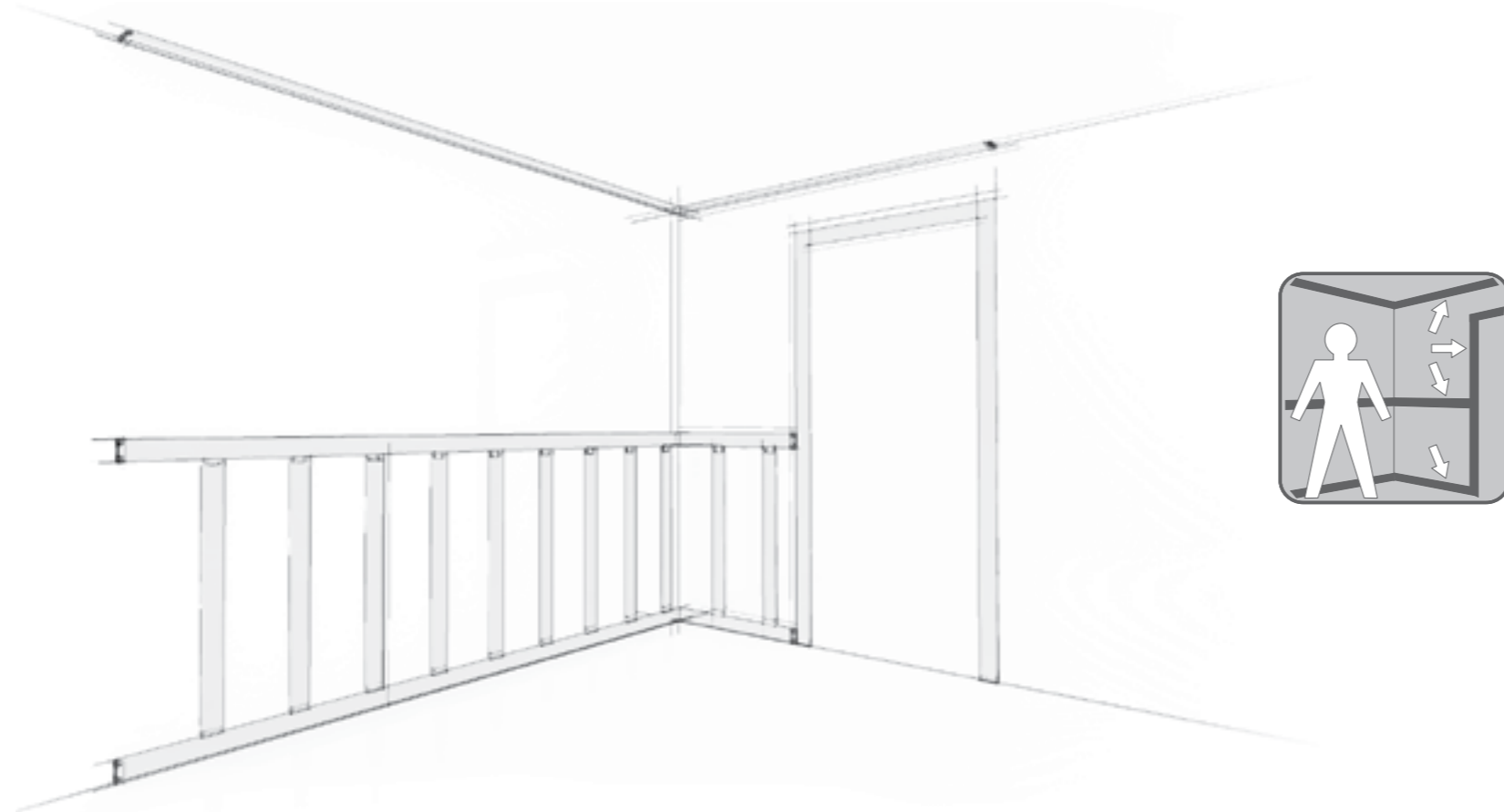

De nieuwe Axxent producten zijn multifunctioneel en kunnen voor verschillende toepassingen gebruikt worden.  
Les nouveaux produits Axxent sont multifonctionnels et peuvent être utilisés pour plusieurs applications.  
The new Axxent profiles are multifunctional and can be used for a variety of applications.  
Die neuen Axxent Leisten sind multifunktional und können in den unterschiedlichsten bereichen eingesetzt werden.  
Las nuevas molduras de Orac Axxent son multifuncionales y pueden ser utilizadas para varias aplicaciones.



Klasse I met aarding - Classe I avec terre  
Safety Class I with earthing - Clase I con tierra  
Schutzklasse I erfordert einer Schutzleiteranschluß



Klasse II met dubbele isolatie - Classe II avec double isolation  
Safety Class II double isolation - Clase II doble aislamiento  
Schutzklasse II doppelte Isolierung



Klasse 3 laagspanning - Classe 3 basse tension  
Safety Class III low voltage - Clase III baja tensión  
Schutzklasse III Sicherheitskleinspannung



12V gelijkspanning - 12V tension continue - 12V constant tension  
12V Gleichstrom 12V - 12V tensión continua



230V  
240V  
50Hz



Beschermingsindicatie - Indice de protection  
Protection level - Schutzklasse  
Nivel de protección



CE norm - CE Norme  
CE Approval - CE Standard  
CE Aprobación



GS-gekeurde producten - Produits avec GS qualification  
GS approved products (tested safety) - Geprüfte Sicherheit  
Productos con GS de cualificación



Energie efficiëntiekwalificatie - Qualification d'efficience d'énergie  
Energy efficiency qualification - Geprüfte Energieeffizienz  
Cualificación de energía eficiente



T5 HE G5 lamp inbegrepen - T5 HE G5 lampe incluse  
T5 HE G5 lamp included - Inklusiv T5 HE G5 Lampe  
T5 HE G5 lámparas incluida



Spaarlamp niet inbegrepen - Lampe économique non incluse  
Energy saving lamp not included - Exklusiv Sparlampe  
Lámpara económica no incluida



MycroLynx lamp niet inbegrepen - Lampe MycroLynx non incluse  
MycroLynx lamp not included - Exklusiv MycroLynx Lampe  
Lámpara MycroLynx no incluida



Niet-dimbaar - Sans variateur  
Not dimmable - Nicht dimmbar  
Sin variador



Dimbaar - Avec variateur  
Dimmable - Dimmbar  
Con variador



Dimbare elektronische ballast - Ballast électronique avec variateur  
Electronic dimmable ballast - Elektronisch dimmbares Vorschaltgerät  
Balastro para variador electrónico



Kleurtemperatuur lamp - Température de couleur lampe  
Colour temperature lamp - Farbtemperatur Lampe  
Vida útil de las lámparas



Minimum afstand tot de muur - Distance minimale du mur  
Minimum distance to wall - Mindestabstand zur Wand  
Distancia mínima de la pared



Uplighter - Luminosité vers le haut  
Uplight - Nach oben leuchtend  
Iluminación hacia arriba



Opbouwarmatuur - Applique murale  
Mounted fixture - Aufputzleuchte  
Aplique para instalación



Downlighter - Luminosité vers le bas  
Downlight - Nach unten leuchtend  
Iluminación hacia abajo



Max. aantal armaturen in één lijn - Max. nombre d'armatures en ligne  
Max. number of fixtures interconnected - Max. Anzahl Verbindungen  
in Reihe - Número máximo de lámparas interrelacionadas



Budgetvriendelijk - Prix économique  
Budget friendly - Preiswert  
Precio económico



Laag energieverbruik - Basse consommation d'énergie  
Low energy use - Niedriger Energieverbrauch  
Consumo mínimo de energía



Makkelijk te installeren - Installation très simple  
Easy to install - Einfach zu installieren  
Fácil de instalar



Geschikt voor directe bevestiging in/op normaal  
ontvlambare oppervlakten  
Convient pour un montage direct dans/sur  
des surfaces inflammables  
Suitable for direct mounting in/on flammable surfaces  
Geeignet für direkte Montage in/auf entflammbare Oberflächen  
Indicado para instalación directa en superficies inflamables

## REGISTERED MODELS:

C351:	000257464-0003	
C352:	000257464-0004	
C353:	000257464-0005	P5051: 000257464-0001
C354:	000257464-0006	P5050: 000257464-0002
C355:	000257464-0007	
C356:	000257464-0008	P8050: 000995576-0003
		P9900: 000995576-0004
C335:	000995576-0001	P9901: 000995576-0005
C336:	001035273-0001	
C990:	000995576-0002	SX156: 000995576-0006

NL			FR			EN					
Brandvoorschriften	112	Panelen	78	Appliques	104	Installation	108	Accessories	107	Mitre box	107
Byblos	76	Pilasters	91	Boîte à onglets	107	LED bars	102	Byblos	76	MycroLynx	105
Consolen	80	Plafonddecoratie	84	Byblos	76	LED insert	105	Capitals (columns)	92-98	Niches	83
DecoFix Extra	106	Plafondtegels	84	Chapiteaux	91-98	Marketing tools	110	Ceiling ornaments	84	Paint	112
DecoFix Hydro	106	Plinten	68	Cheminées décoratives	81	Moulures flexibles	71	Ceiling tiles	84	Panels	78
DecoFix Pro	106	Poluyrethaan	38	Cimaises	60-67	Murs courbés	71	Ceiling roses	86-89	Panel mouldings	60-67
Deuromlijstingen	72	Purotouch®	38	Colles d'installation	106	MycroLynx	105	Columns	92-98	Pediments	74
Deurpanelen	78	Ronde muren	71	Colonnes	92-98	Niches	83	Corbels	80	Pilasters	91
Duropolymere®	40	Rozassen > rozetten	86-89	Consignes d'incendie	112	Outils	107	Cornice mouldings	42-58	Polyurethane	38
Flexibele lijsten	71	Schachten	92-98	Colonne segmentée	98	Panneaux	78	Deco elements	82	Purotouch®	38
Garantie	112	Schappen	80	Consoles	80	Panneaux de portes	78	DecoFix Extra	106	Rounded walls	71
Gereedschap	107	Sierelementen	82	Corbeaux > consoles	80	Peinture	112	DecoFix Hydro	106	Safety regulations info	112
Gesegmenteerde zuil	98	Sierschouwen	81	Corniches	42-58	Pilastres	91	DecoFix Pro	106	Saw	107
Halve zuilen	95-97	Sokkels	92-98	Coupoles	85	Pistolet à colle	107	Domes	85	Segmented column	98
Indirecte verlichting	101	T5 Tube	103	Dalles de plafond	84	Plinthes	68	Door frames	72	Shelves	80
Installatie	108	Timpaan > fronton	74	DecoFix Extra	106	Poluyréthane	38	Door panels	78	Skirting	68
Installatielijm	106	Variomatic	107	DecoFix Hydro	106	Purotouch®	38	Duropolymere®	40	Socle	92-98
Kaderlijsten > wandlijsten	60-67	Veiligheidsinformatie	112	DecoFix Pro	106	Rosaces > rosettes	86-89	Fire retardant standards	112	T5 Tube	103
Kapitelen	91-98	Verf	112	Décoration murale	82	Scie	107	Fixtures	104	Variomatic	107
Koepels	85	Verlichting	100-105	Décoration de plafond	84	Socles	92-98	Flexible mouldings	71	Wall decoration	82
Kolommen > zuilen	92-98	Verstekbak	107	Demi-Colonnes	95-97	T5 Tube	103	Glue	106	Warranty	112
Kraagstuk > console	80	Voetstukken > sokkels	92-98	Duropolymere®	40	Tympan > fronton	74	Glue pistol	107	Xinnix®	105
Kroonlijsten	42-58	Volle zuilen	92-94	Eclairage	100-105	Variomatic	107	Half Columns	95-97		
LED bars	102	Wandlampen	104	Eclairage indirecte	101	Xinnix®	105	Lighting	100-105		
LED insert	105	Wandlijsten	60-67	Eléments décoratifs	82			Indirect lighting	101		
Lijmen	106	Xinnix®	105	Encadrements > cimaises	60-67			Installation	108		
Lijmpistool	107	Zaag	107	Encadrements de portes	72			LED bars	102		
Marketing tools	110	Zuilen	92-98	Etagères	80			LED insert	105		
Muurdecoratie	82			Fûts de colonnes	92-98			Marketing tools	110		
MycroLynx	105			Garantie	112			MycroLynx	105		
Nissen	83			Information de sécurité	112			Nischen	83		
								Paneele	78		

DE			ES				
Armaturen	104	Pedimente	74	Accesorios	107	Molduras flexibles	71
Beleuchtung	100-105	Pilaster	91	Apliques para la pared	104	MycroLynx	105
Brandvoorschriften	112	Polyurethan	38	Byblos	76	Nichos	83
Byblos	76	Purotouch®	38	Caja ingletadora	107	Paredes redondas	71
Deckenziererelemente	84	Rosetten	86-89	Capiteles	92-98	Paneles	78
Deckenplatten	84	Säge	107	Chimeneas decorativas	81	Pilastras	91
DecoFix Extra	106	Säulen	92-98	Clasificación al fuego	112	Pintura	112
DecoFix Hydro	106	Segmentierte Säule	98	Cola para la instalación	106	Pistola para colas	107
DecoFix Pro	106	Schaft	92-98	Columnas	92-98	Poliuretano	38
Dome	85	Sicherheitsinformationen	112	Columnas segmentadas	98	Purotouch®	38
Duropolymere®	40	Socket	92-98	Cupole	85	Rodapiés	68
Eckleisten	42-58	Sockelleisten	68	DecoFix Extra	106	Rosetones	86-89
Farbe	112	T5 Tube	103	DecoFix Hydro	106	Sierra	107
Flexible Leisten	71	Türumrandungen	72	DecoFix Pro	106	T5 Tube	103
Garantie	112	Türpanelee	78	Decoración de paredes	82	Variomatic	107
Gebogene Wände	71	Unterbau > Konsole	92-98	Decoraciones para techo	84	Xinnix®	105
Gehrungslade	107	Variomatic	107	Duropolymere®	40	Zócalos	68
Halbsäulen	95-97	Wandbords	78	Elementos decorativos	82		
Indirekte Beleuchtung	101	Wanddekoration	82	Estanterías y ménsulas	80		
Installation	108	Wand- und Friesleisten	60-67	Frontones	74		
Kamine	81	Zierelemente	82	Garantía	112		
Kapitelle	92-98	Zubehör	107	Iluminación	100-105		
Kleber	106	Xinnix®	105	Iluminación indirecta	101		
Klebstoffpistole	107			Información de seguridad	112		
Konsolen	80			Instalación	108		
LED bars	102			LED bars	102		
LED insert	105			LED insert	105		
Marketing tools	110			Marcos de puertas	72		
MycroLynx	105			Marketing tools	110		
Nischen	83			Medias Columnas	95-97		
Paneele	78			Cornisas	42-58		

<b>B</b>	C321/C321F	43/44	CX100	52	D507	78
B401	C322/C322F	43	CX101	53	D101	72
B402	C331/C331F	44	CX106	53	D1010	72
B403	C332	45	CX107	53	D1014	72
B404	C332bis	43	CX108	52	D102	72
B408	C333/C333F	45	CX109	52	D200	72
B409	C334/C334F	45	CX110	52	D210	72
B410	C335	47	CX111	51	D300	72/77
B413	C335+P9901	47	CX112	52	D310	72
B414	C336	48	CX115	51	D320	91
B417	C337	47	CX123	52	D62	72
	C337bis	48	CX124	52	DX119 - 2300	72
	C338	47	CX126	53	DX121 - 2300	72
	C339	45	CX127	53	DX157 - 2300	67/68
C200/C200 F	C340	48	CX128	53	DX159 - 2300	68
C201/C201F	C351	58/101	CX129	53	DX162 - 2300	67/68
C211/C211F	C352	58/101	CX132	51/68	DX163 - 2300	67/69
C212/C212F	C353	42	CX133	51/68	KX001	73
C213/C213F	C354	42	CX134	67	KX003	73
C214/C214F	C355	42	CX136	53	D120	74
C215/C215F	C356	42	CX148	52	D140	74
C216/C216F	C357	58/101	CX154	51	D150	74
C217/C217F	C358	58/101	CX160	51	D161	74
C217 bis	C360	42	CX161	51	D170	74
C218/C218F	C361	58/101	CB500	56	D400	74
C219	C362	58/101	CB501	56	D401	74
C220/C220F	C363	58/101	CB502	57	D402	75
C230/C230F	C364	58/101	CB503	57		
C240/C240F	C364A	58/101	CB510	56	<b>F</b>	
C250/C250F	C400	44	CB511	57	F10	85
C260/C260F	C402/C402F	49	CB512	57	F11	85
C300	C422	50	CB520	56	F12	85
C301/C301F	C602/C602F	43	CB521	57	F30	78/84
C302/C302F	C900	45 / 59 / 100	CB522	57	F31	78/84
C303/C303F	C901/C901F	45 / 59 / 100	CB523	56	FX200	107
C304/C304F	C902/C902F	45 / 59 / 100	CB530	56	FDP500	107
C305	C990	46	CB530 bis	56	FDP600	107
C305+C212	C990+P9900	46	CB531	56/57	FDP700	107
C305+C213	C990+2x P9900	46	CB531 bis	56	FX200	107
C305+C211	C990+P9900 bis	46			FX210	107
C305+C321	C990+P9901	47	<b>D</b>		FB13	107
C307	C990 bis	46	D500	78	FB14	107
C307A	C990 bis+2x P9900	46	D503	78	FB15	107
C307+C307A	C990 bis+P9900 bis	46	D504	78	FB300	107
C308/C308F	C990 bis+P9901	47	D506	78	FB10	107

<b>G</b>	K1121	95/96
G40	K1141	95/96
G42	K3111	96/97
G50	K3141	96/97
G51	K1001	95/96
	K1101	95/96
	K3001	96/97
	K3101	96/97
	K3201	97
	K1131	95/96
	K1151	95
	K2131	96/97
	K3151	97
	K4131	98
	K4001	98
	K4121	98
	K1112	92/93
	K1122	92/93
	K1142	92/93
	K3112	93/94
	K3142	93/94
	K1002	92/93
	K1102	92/93
	K3002	93/94
	K3102	94
	K3202	94
	K1132	92/93
	K1152	92
	K2132	93/94
	K3152	94
	K4002	98
	K4122	98
	K4132	98
<b>L</b>		
L501	L501	104
L504	L504	104
L505	L505	104
L506	L506	104
L509	L509	104
L512	L512	104
L600-001	L600-001	105
L601-001	L601-001	105
<b>M</b>		
K1111		95/96

M9010A	77	P8060/P8060F	60	R24	89
M9010B	77	P9010/P9010F	61	R27	89
M9010C	77	P9020/P9020F	61	R28	89
M9010LR	77	P9040/P9040F	60	R31	87
		P9050/P9050F	60	R35	86
		P9900/P9900F	46/61	R38	89
		P9901/P9901F	47/60	R40	86
		P4020A	62	R46	88
		P5020A	61	R50	87
		P5020B	61	R52	89
		P801C	62	R61	87
		P8030C	62	R64	89
		P8030D	62	R66	86
		PB513	57	R73	89
		PB513A	57	R74	88
		PX102	67	R76	86
		PX103	66	R77	88
		PX103A	67		
		PX103A + PX103	67	<b>S</b>	
		PX113	66	SX104	69
		PX114	66	SX105/SX105F	69
		PX116	66	SX118/SX118F	69
		PX117	66	SX155/SX155F	69
		PX120	66	SX156	69
		PX120A	67	SX122	68
		PX120A + PX120	67	SX125	68
		PX131	66	SX137	68
		PX144	66	SX138	69
		PX147	67		
		PX164	51/67		
				<b>R</b>	
				R07	86
				R08	86
				R09	86
				R10	87
				R11	87
				R12	87
				R13	87
				R14	87
				R16	88
				R17	88
				R18	88
				R22	88
				R23	89



42



60



68



71



72



74



76



78



80



82



83



84



86



91



92



100



Wij danken iedereen die meegewerkt heeft aan de realisatie van deze brochure. Nous remercions tout le monde qui a collaboré à la réalisation de ce catalogue. We would like to thank everybody who helped with the creation of this brochure. Wir danken allen Personen, die an der Herstellung dieser Broschüre mitgewirkt haben. Agradecemos la colaboración a todas las personas que han participado en la realización de este catálogo.

Projects: 'Coca-Cola Loge' by Pinkeye (BE) - [www.pinkeye.be](http://www.pinkeye.be)  
 Hotel Majestic (ES) - [www.hotelmajestic.es](http://www.hotelmajestic.es)  
 Restaurante Boca Grande (ES)  
[www.metiendovivendum.com](http://www.metiendovivendum.com)

Eichholtz A'dam (NL) - [www.eichholtz.com](http://www.eichholtz.com)  
 Hotel the Black Antwerp (BE) - [www.hoteltheblack.be](http://www.hoteltheblack.be)  
 Restaurante La Rambla by Ana Generó (ES) - [www.larambla.biz](http://www.larambla.biz)  
[www.houseofporters.com](http://www.houseofporters.com)

Balo 'Living in Style' (BE)- [www.balolivinginstyle.be](http://www.balolivinginstyle.be)  
 Private residence, Ponseele (BE) - [www.patrickponseele.be](http://www.patrickponseele.be)  
 Hotel Alma (ES) - [www.almabarcelona.com](http://www.almabarcelona.com)

This catalogue and the designs embodied within are protected by copyright law and international treaties. Unauthorized reproduction of the catalogue or any portion of it or reproduction of any of the designs embodied therein may result in severe civil and criminal penalties and will be prosecuted to the maximum.



WWW.ORACDECOR.COM

MP040/001

NL-FR-EN-DU-ES 01/2012

★ **ORAC HEADQUARTERS**

**NV ORAC SA**

BIEKORFSTRAAT 32,  
8400 OSTEND, BELGIUM  
T +32 (0)59 80 32 52  
F +32 (0)59 80 28 10  
INFO@ORACDECOR.COM

★ **ORAC FRANCE**

T 0800-900 358  
F +32 (0)59 80 28 10  
FRANCE@ORACDECOR.COM

★ **ORAC DEUTSCHLAND**

T 0800-181 3694  
F +32 (0)59 34 05 24  
DEUTSCHLAND@ORACDECOR.COM

★ **ORAC (UK) L td.**

ELMBRIDGE ROAD UNIT 5  
HEWITTS E STATE  
CRANLEIGH, SURREY  
GU6 8LW  
UNITED KINGDOM  
T +44 (0)1483 271 211  
F +44 (0)1483 278 317  
UK@ORACDECOR.COM

★ **ORAC SLOVAKIA S.R.O.**

KPT. NALEPKU 6  
SK-08271 LIPANY  
T +421 (0)514-891 581  
F +421 (0)514-573 595  
SLOVAKIA@ORACDECOR.COM

★ **ORAC SPAIN**

T 0900 99 32 89  
F +32 (0)59 80 28 10  
SPAIN@ORACDECOR.COM

★ **ORAC NEDERLAND**

T 0800-022 2125  
F 0800-022 2138  
NEDERLAND@ORACDECOR.COM