



MODERN

ORAC[®]
DECOR

No Boundaries The mind has no limits. Pure creativity will always supersede prescribed codes because fantasy is unbridled and cannot be forced into compliance. This is MODERN. These are unlimited possibilities.



Index

The new Orac Decor® decorations provide the freedom to design and express yourself. Just as modernists have been using new technologies to amaze through symmetry, proportions and simplicity, our five product groups allow you to infuse architecture and interiors with your personality, without restraint. Pure lines, striking finishes or lighting and decorative elements that tell your own story: it's all up to you.

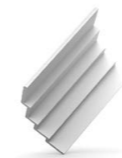

Cornice mouldings
Spacious effect



Panel mouldings
Create a sense of depth



Skirting boards
The perfect finish for floors



Indirect Lighting
LEDS set the mood



Decorative elements
An arty touch

P.006 Designers speak
P.014 Freedom to think and do
P.016 A personal space
P.022 Infinity and beyond
P.024 Map of the world
P.026 ORAC® Headquarters
P.030 A visit to the lab

P.034 Camping out with Pascal
P.038 Art with Orac Decor®
P.040 Sustainability
P.042 Inspiration
P.056 Modern vs. traditional
P.058 Product overview
P.076 The Perfect Finish



www.interiorismo.com

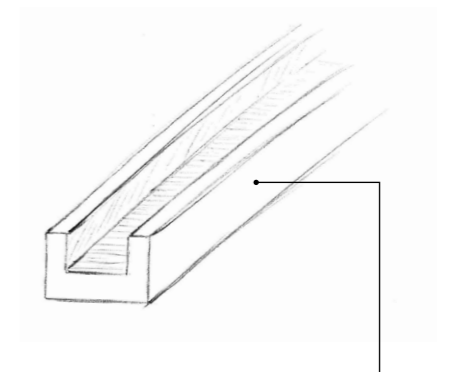

CX190 U-Profile

Time to shine

LONG LIVE LIGHT, SHADOW AND ATTENTION

MEET MARISA

Interiorismo by Marisa Gallo is an international interior design firm that operates out of Madrid to design residential and commercial properties in Spain and Latin America. Its constant quest for uniqueness and balance has resulted in a distinctive style synonymous with elegance and timelessness.



A wonderful effect. A distinctive wall with decorative elements and pleasing LED lighting thanks to the innovative U-profile. Designer Marisa Gallo: "The intelligent design of these Duropolymer® profiles allows the same product to be used as smooth panel moulding, skirting boards and as a lighting fixture. This creates many possibilities, especially when combined with direct lighting. The material is so versatile that it is suitable for any space. It can either be used as a panel moulding or as a cornice, to create a feeling of spaciousness. The moulding also hides cables to create a more finished design."

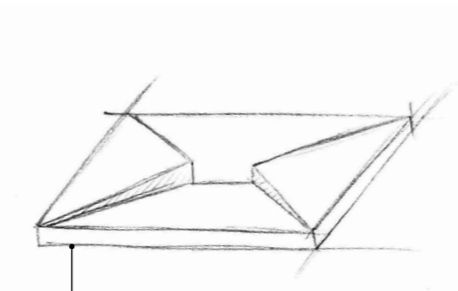

W106 Envelop

Natural beauty

ADD A NEW DIMENSION

MEET ANASTASIA

"Anything is possible and so much more." This is the motto of designer Anastasia Danilova. From her headquarters in Krasnodar, Russia she gains name and fame with her spatial designs in which humans and the environment go hand in hand.

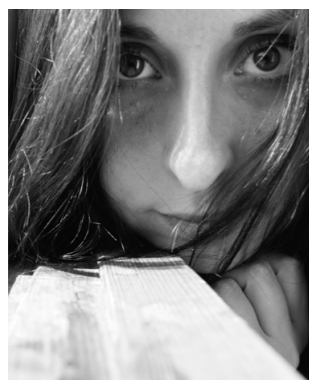

Nature teases all the senses. Designer Anastasia Danilova uses the power of the Envelop 3D panelling to create rhythm and depth for extra dimension. "Orac Decor® elements are the perfect foundation to express your own ideas. You can paint, compose and combine one or many, many elements. The 3D panelling provides plenty of room for your imagination. It's like a childhood diorama. Anyone can create unique patterns to fit their own taste. The result is an intensely personal space with a multi-faceted interplay of shadows and effects. Like here: all elements are linked. Nature and art. It represents simplicity, but also luxury. The accent wall creates the illusion of reptile skin and provides the space with the needed balance."





www.zarizaart.ru

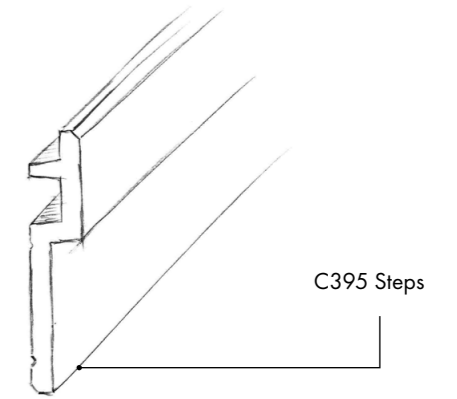

C395 Steps

individual rooms are merged into a unified whole

STYLE AND PERSONALITY UNITE

MEET ZARIZA ART

The interior designers at Zariza Art design stylish and luxurious residential projects from their home based in Volgograd. Their vision - learn, do, love - is reflected in casual designs and innovative applications.



With Steps as their guide, Zariza Art's interior designers create a light interior with character and personality. However these profiles are used, the results are always different depending on the combination, length, shape and colour. That flexibility in interpretation is exactly what makes it so great. The geometrical interaction of horizontal and vertical lines joins contrasting spaces. Steps can be used as a cornice moulding, decorative moulding and indirect lighting. "Thanks to the new MODERN collection, individual rooms are merged into a unified whole."

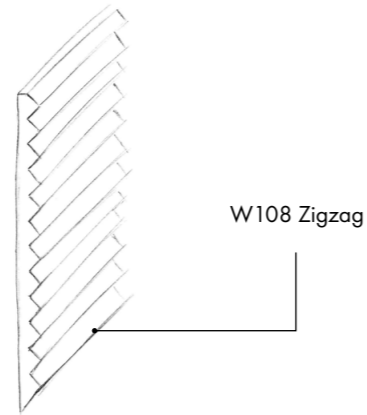
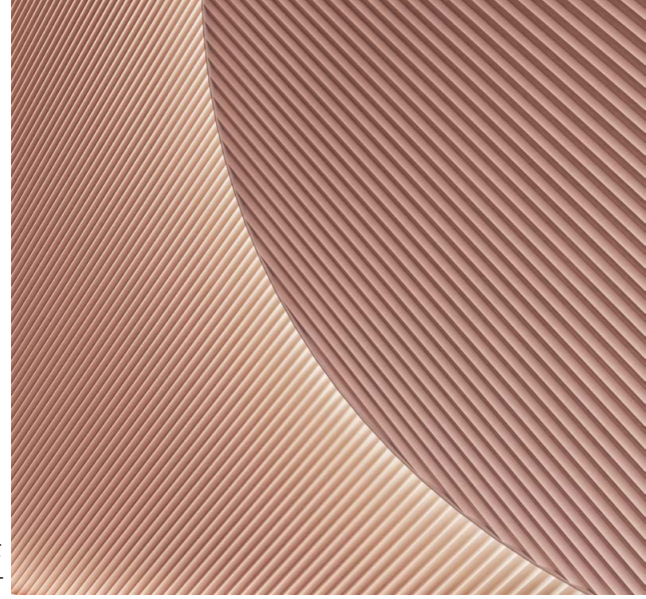

Play with direction and depth

EXCITEMENT IN MONOCHROME

MEET BRAM COUVREUR & BJÖRN DE VOS

Designers Bram & Björn are a member of the Belgian creative agency Maister. Detailing and a well-considered choice of materials are typical for the interior and product design, which among other acknowledgements, won a Henry van de Velde Award.



An interior that comes alive thanks to the unique wall effect. "Zigzag is a very rewarding 3D panelling," states designer Björn Devos. "Simple variations in direction create movement and contrast, even when using a single, soothing colour range. The 3D effect is amplified through the use of rounded, organic shapes. This creates an exciting interplay of lots of indirect lighting and unexpected angles. Even for furniture: Zigzag can be used anywhere, and painted too."





LAURENCE, GUY & YVES TAILLIEU

“

*It's our customers that truly
create beauty from our products.
Orac Decor® provides the building
blocks and inspiration.*

HALF A CENTURY OF PASSION FOR INTERIORS

We don't create profiles — we create freedom

The MODERN collection consists of straight lines, but at the same time is not restrictive. The interaction between the various applications is so much greater than what was traditionally possible. The possibilities are endless. "Precisely that freedom is what defines our Modernism. Solutions to fit every budget result in architectural details with a great aesthetically added value. We provide a simple way to add balance and harmony to your interior. We will proudly continue along this path for the next few years", says Yves, who together with his sister Laurence, drives the family business towards new heights.

Pure shapes for endless possibilities

GIVE YOUR SPACE PERSONALITY

Cornice mouldings to cover walls. U-profiles as lighting fixtures. Wall tiles as art installation. MODERN profiles can't be pigeon-holed.

Welcome to the House of Personality. The Orac Decor® inspiration centre where new concepts and combinations are given shape. A place where unbridled creativity is given free rein and there are no boundaries thanks to the insight and imagination of Orio Tonini, the designer of the new profiles. "The ornaments transform from being pure decorative elements into part of the architecture."



ORIO TONINI

ENDLESS COMBINATIONS

Orio Tonini is an architect, designer, Italian and resident of Amsterdam. He combines all his new Orac Decor® designs into a unified whole at the Orac Decor® inspiration centre but not in the way you would expect. The various elements of the Steps range – designed as a cornice moulding – create a refined interplay of depth and lines and seamlessly continue as a pelmet. The linear U-profile creates new opportunities for unlimited use of LED lighting and the cosiness of dimmed lights. It can be used to create a playful labyrinth of uplight, downlight and flat panel mouldings. “The shape is pure: refined to its essence. This is precisely what enables an endless variety of applications. What you see here is only a sample of what’s possible. Your imagination is the only limit.”



“ The U-profile provides a labyrinth of uplight, downlight and flat panel mouldings.

“

The space is vibrant. And that's accomplished solely through the use of grids, light and shadow.



MORE THAN ACCENTS

“The results are better than a painting. A painting never changes, whereas a wall installation that plays with light, shadows and different angles, does.” Such as the eye-catching wall where Zigzag dominates the entire surface area with plenty of attention paid to detailing, grids and a playful arrangement of the various surfaces. “The space is vibrating”, laughs Orio. “These are minor modifications that provide some nice accents and easily function as problem solvers. To hide irregularities, for example. Yes, even there you determine your own boundaries.”



BJORN VERLINDE

“

I want to set others' imagination to work. Inspire them to do things differently.

SPACE SHIP AS TRADE FAIR BOOTH

To infinity and beyond

THE BACKGROUND STORY

Inspired by the boundless appeal of space yet to be explored, Bjorn created a space ship as our trade fair booth for Interieur '18 (Kortrijk, Belgium). Courageous "Oracians" use it to explore the galaxy in search of the concept of "boundless aesthetics". Once landing on a desolate planet where it's possible to submerge themselves in a pure environment, free of baggage or influences, the mission then begins. After dozens of years of research, they build a Test Capsule to explore the NO BOUNDARIES level of an item.

IMAGINATION AS INSPIRATION

Verlinde doesn't do traditional. Cornice mouldings, panel mouldings, skirting boards and indirect lighting float, tip and come to an abrupt stop. The space ship consists entirely of Orac Decor® profiles. Each element is the beginning of a new story. An ostensibly traditional product such as a decorative moulding can take you on a journey to a futuristic dimension. All aspects are surprising. From the space ship entrance to the Test Capsule. "I want to inspire others to do things differently. Leave the well-trodden pathways. Look further than the standard solution. Orac Decor® elements are perfect for that. The material is so versatile, easy to manipulate and fit in. A very affordable way to create spectacular effects. Especially in modern or even futuristic environments."



Orac Decor® profiles along the entrances, exterior seams and covering the entire interior turn this trade fair booth into a 'real' space ship.

ORAC[®] is active in 90 countries

With three production plants and four sales locations, a strong dealer network has been created, resulting in a global presence. A story about how inspiration and creativity know no boundaries...

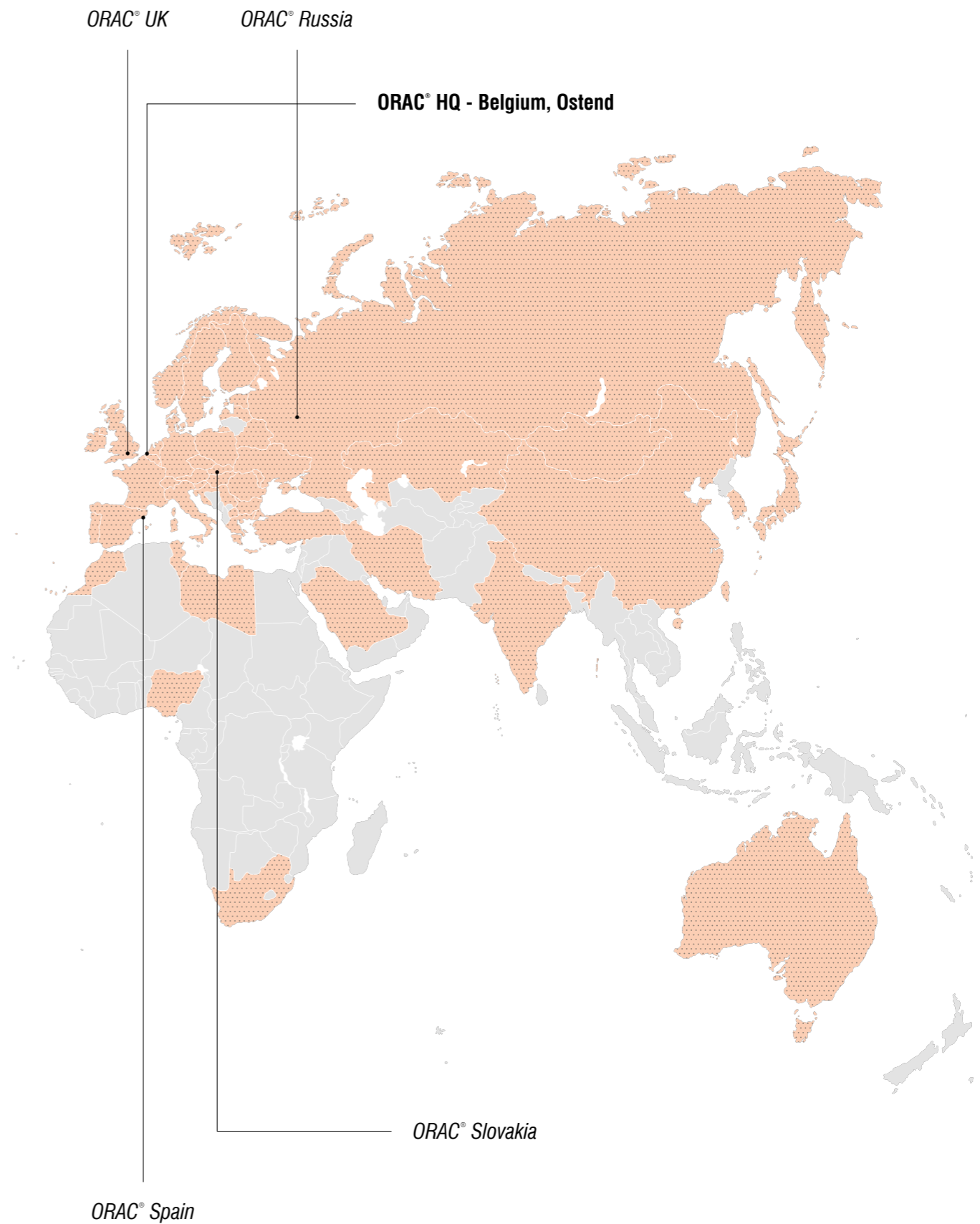
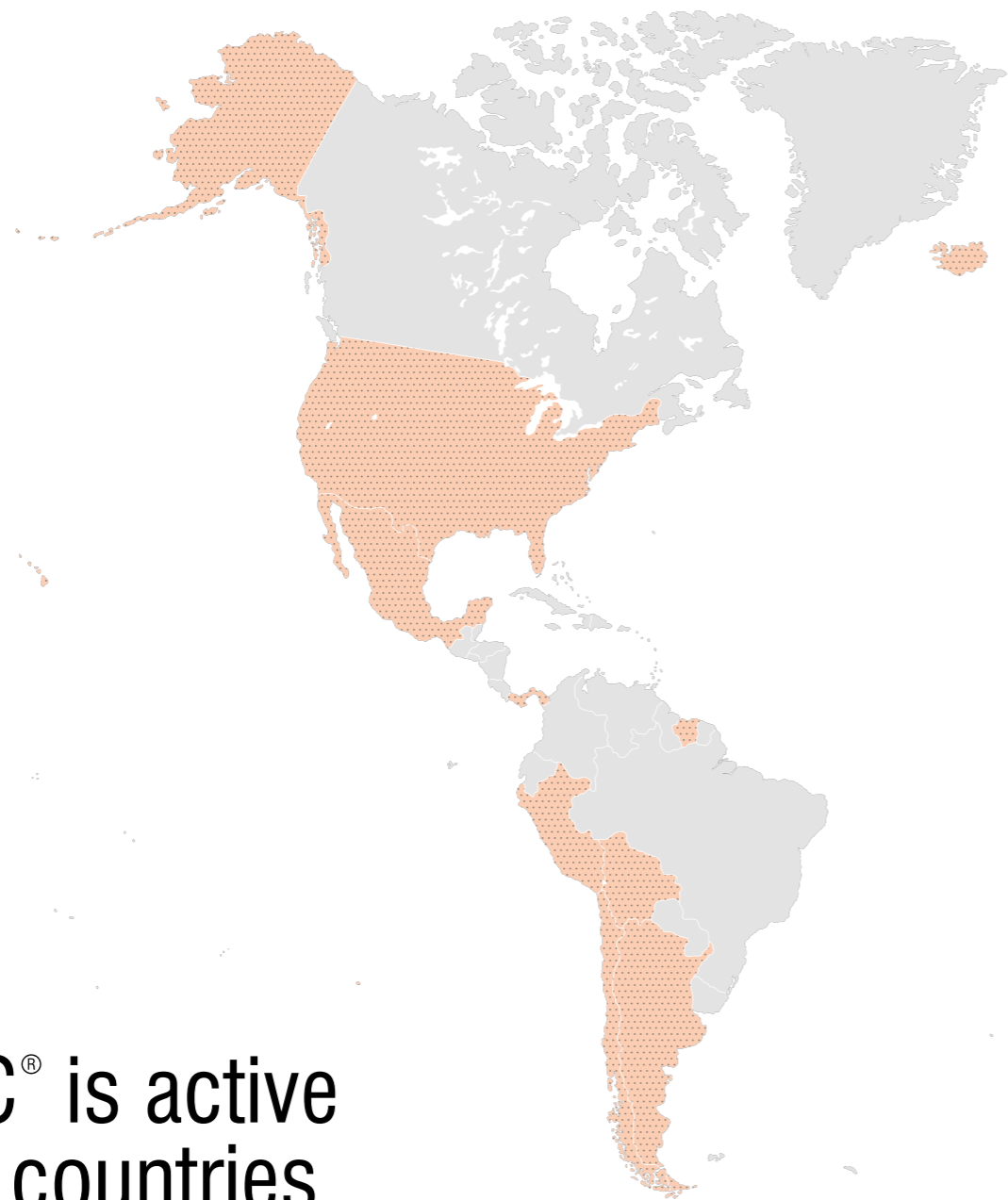



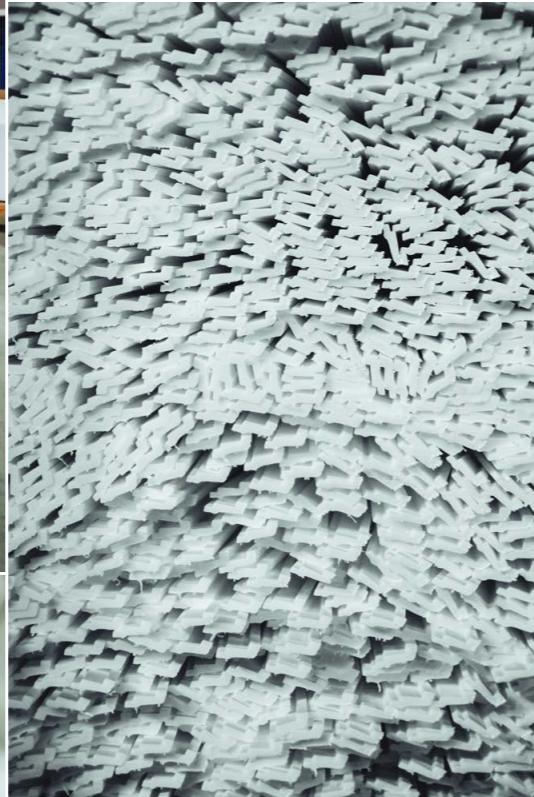
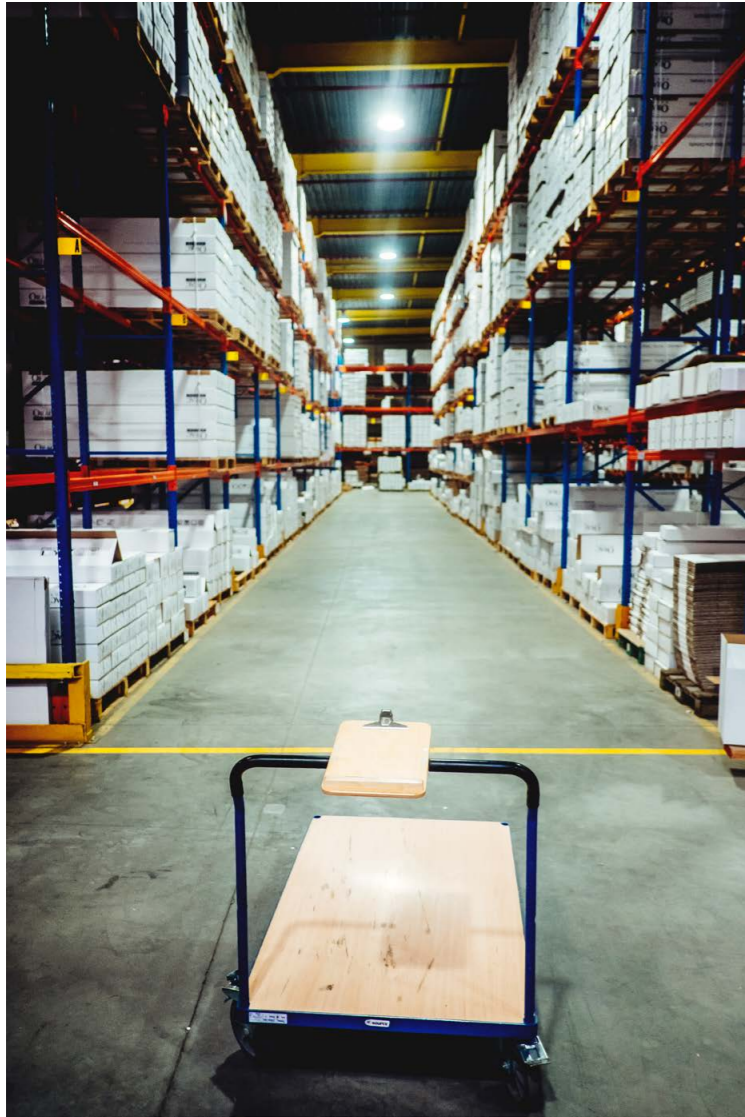

Facts & Figures

3.000

Rooms are decorated using Orac Decor® products daily

26.000

Designers collaborate with Orac Decor®

40.000

Painters install Orac Decor®

1992

Orac Decor® is the first to bring flex products to market

2005

Orac Decor® introduces the first modern collection

2012

Orac Decor® launches the Ulf Moritz design collection

2015

Orac Decor® launches various types of cover skirting

48

Years brimful of passion for interiors

290

Kilometres of indirect lighting sold by the meter annually



Knowledge is the key that opens all doors

A VISIT TO THE LAB

A sketch consists of a few lines on a sheet of paper. A real design is three-dimensional, mathematically correct, scientifically grounded and visually flawless. If you ask Johan Cottyn, that is. Johan has been working as an engineer for Orac Decor® for fifteen years now, providing the brains that transform virtual designs into user-friendly products. "And still, I'm surprised by the new possibilities on a daily basis."

OWN DEVELOPMENT

"Of course the industry has standard tests to determine the quality. We go beyond that. We design our own tests. That's because our products are so complex and our materials cutting-edge. Each design is subjected to multiple checks. The objective is always the same: to provide optimal quality." In Purotouch®, Duropolymer® and Durofoam®, ORAC® developed three proprietary, protective synthetic materials. "Each with unique characteristics to provide even better results for the desired application. From fine detailing or high impact resistance to very low weight or high flexibility. The possibilities are endless."

TECHNOLOGICAL (R)EVOLUTION

"Technology is constantly changing and everyone is crazy for innovation. Acting quickly, responding and a daily drive to improve - those are our challenges. Our knowledge is both in-house and from external sources. We continue to innovate in collaboration with customers, dealers, architects, universities and more. The true path to doing more is knowing more."



“

From fine detailing or high impact resistance to very low weight or high flexibility. The possibilities are endless.

This is my freedom

CAMPING OUT WITH PASCAL

Seeking your own limits. Going where none have gone before. These could just be design slogans, but what they are is Pascal Helsmoortel's motivation. By day he's one of the experienced technicians that keep the machines at ORAC® running smoothly. By night and on holiday, he invests all his time in his other passion: camping in the wild thanks to his old Ford Transit that he's transformed into a home on wheels.

If, while hiking in a remote German or English forest, you spot some distinctive blue lines with round headlights, you may have just crossed paths with Pascal and his family. "We always camp out in the wild, somewhere as remote as possible. To stop and go wherever you please: that's true versatility."



“ *It's a matter of making plans and seeing solutions, not problems.* ”

“

*Stop and go wherever
you please: that is
true freedom.*

A HAMMER AND A SPANNER

In barely a year and a half, Pascal has travelled across half of Europe in his vintage camper. The fact that the ancient mechanics tend to fail occasionally just adds to the adventure. “You’re on your own. I always take along a hammer, an adjustable spanner and a screwdriver. And I always manage to resolve the issue. It’s a matter of making plans and seeing solutions, not problems. Besides, working on old-timer technology is great fun. You can actually do the work yourself.”



HIGHER GEAR

Rolling up your sleeves, being crazy about something and able to invest your love and passion. That’s what drives Pascal. Engines and technology are the technician’s life. It need not be said that a forty-year-old delivery van isn’t the most secure means of transport. Pascal’s most radical intervention? A complete gearbox replacement. Not in a garage, but somewhere by the side of an empty motorway. Why call for roadside assistance if you can do it yourself, after all? “It did cost me a few hours, but I managed to get the camper back on the road in the end,” he smiles. Those who know Pascal know the engine certainly won’t quit. He makes sure of that personally. “Someday I hope to fulfil my dream: making a trip around the world with my old Transit.”



www.studiobambam.be

Freedom for artistic spirits

STUDIO BAM BAM

Unexpected, intriguing and always colourful. Work by Ghent visual artist Benjamin Van Oost – Studio Bam Bam to his friends – is a pleasure to experience, full of 3D objects and utopian angles. Although you can usually only understand in hindsight.

“ Each perspective provides new insights and different accentuation.

“The result is always a collage, just as a DJ is inspired by samples of existing compositions. That’s how I let myself be guided by Orac Decor® samples,” Benjamin declares. “The material is available in many different shapes, in various designs and it can be endlessly manipulated or painted.” It’s soon clear that the work perfectly reflects the philosophy of boundless possibilities: “There is no front or back. No top or bottom. Each perspective provides new insights and different accentuation. It’s fun, spatial and open to interpretation. Everyone has and experiences their own reality. To some, the colours reference Pop Art and for others, the lines and various elevations create a futuristic cityscape.”



“

We treat our raw materials with respect. All cooling water and waste materials are re-used internally.

Less waste — more natural energy

THE GREEN PRINCIPLE IN FOUR STATEMENTS

“There’s only one world. It’s logical that we must do all we can to keep it as good and beautiful as possible. Right? Both for ourselves and for subsequent generations” says Nico Wynthein, responsible for quality and the environment at ORAC®.

100% SUSTAINABLE

Sturdy, water-resistant and sustainable. Orac Decor® design elements are designed and manufactured to survive lifelong wear and tear. “This is our answer to the disposable culture in which raw materials only get used once. We invest in the future. Both in our products and in the people who use them.”

ISO 14001

This technical standard defines and rewards environmentally friendly production. “We have proudly sported this certificate for seven years now. It proves we are leaders, not followers. Our own targets have been stricter than those prescribed by the government for many years.”

REDUCE/RE-USE

“Today, we recover and re-use all our cooling water. All waste materials are recycled and re-used internally. The lighting and production processes are computer-controlled for optimal efficiency and so on. Every day we strive for further improvement.”

25% RENEWABLE ENERGY SOURCES

The entire roof of our production plant in Ostend is covered in solar panels. “We aim for twenty-five percent renewable energy. The solar panels are the first step. They already supply ten percent of our power needs today.”





Inspiration



💡 *Indirect lighting takes your space to a higher level.*



💡 *Decorative or purely functional. You always have a unique fixture with the U-profile.*



💡 Hide curtain rods while emphasising the architecture.

💡 A winning combination. Mount indirect lighting under your cornice moulding for a more spacious effect.

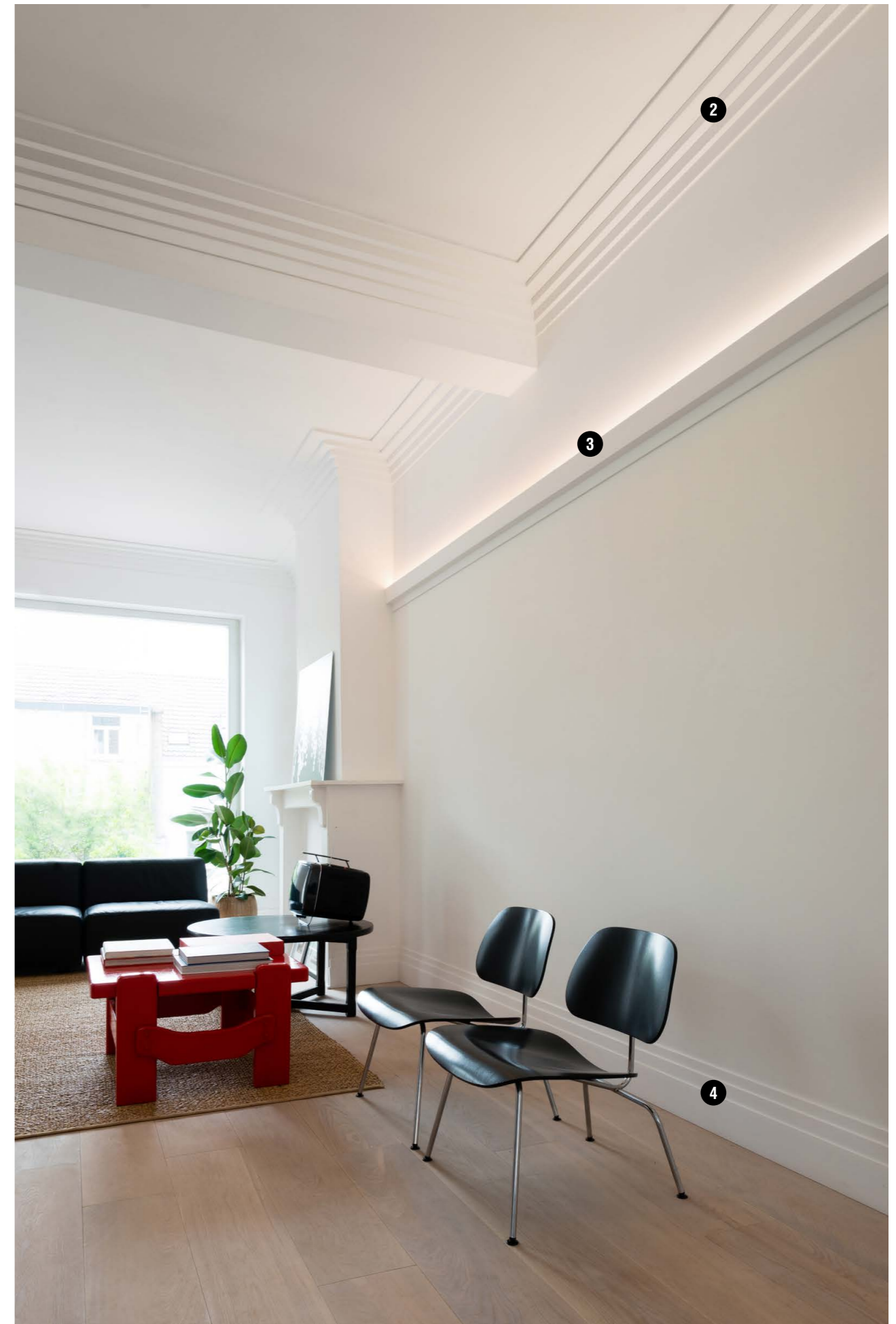

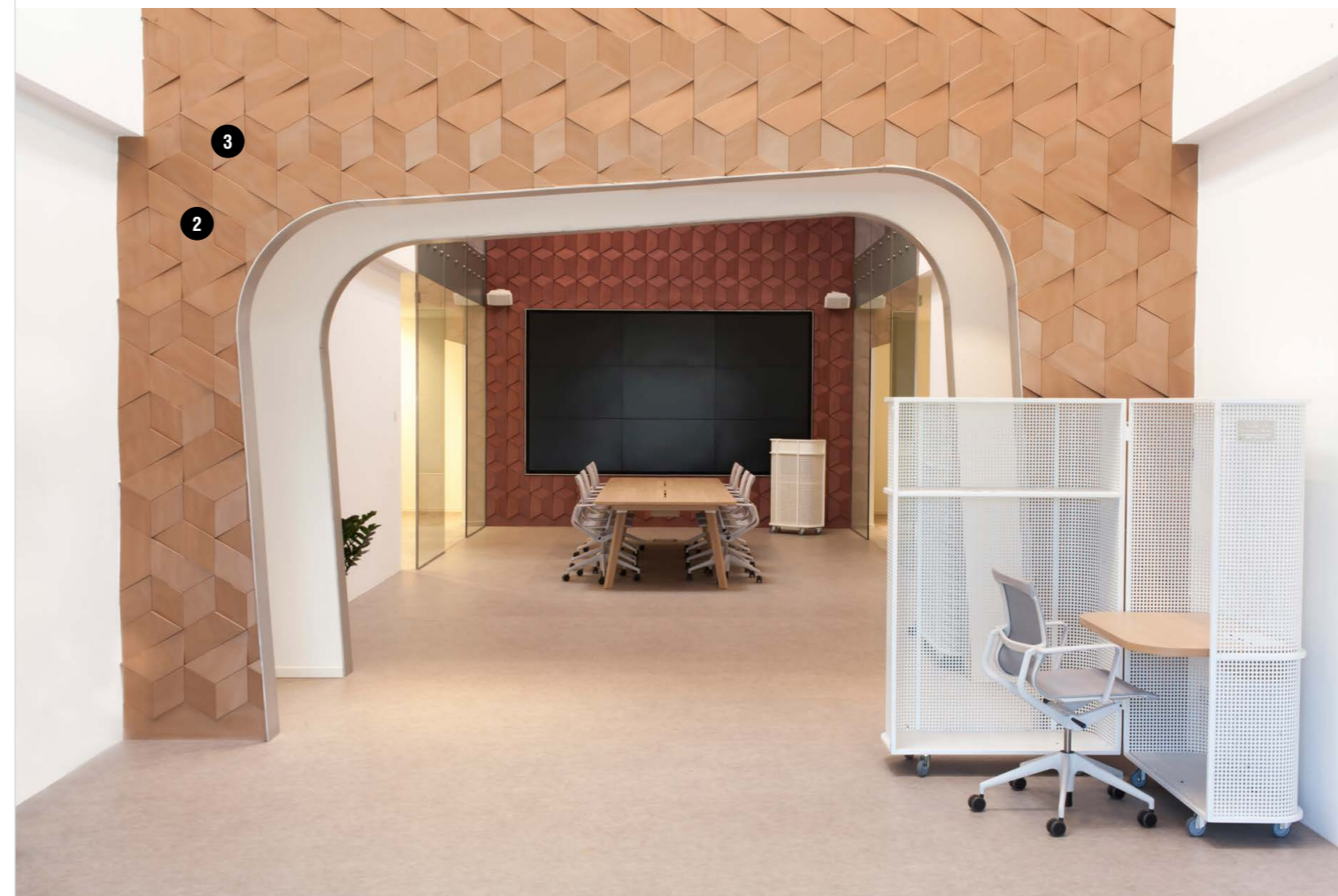

💡 *The wall as your canvas. Use our panel moulding to turn your wall into a work of art.*

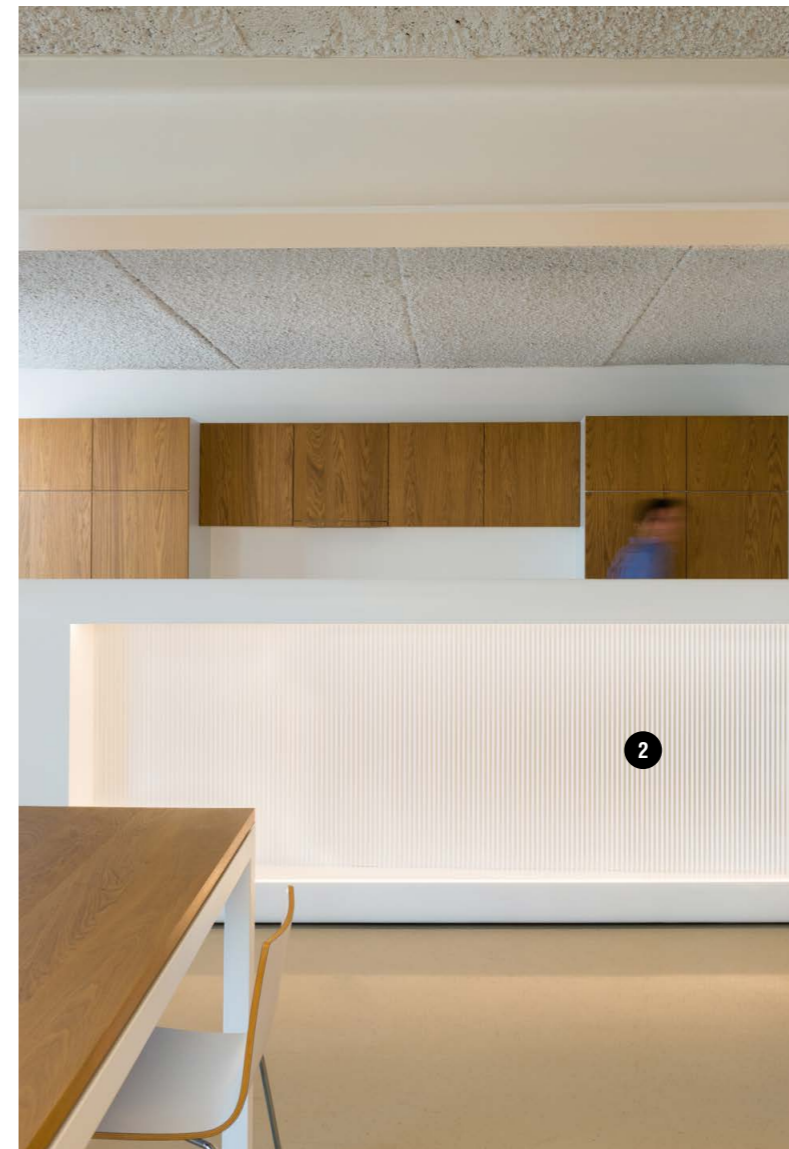

💡 *Instant class. Subtle or less subtle wainscoting takes your space to a higher level.*

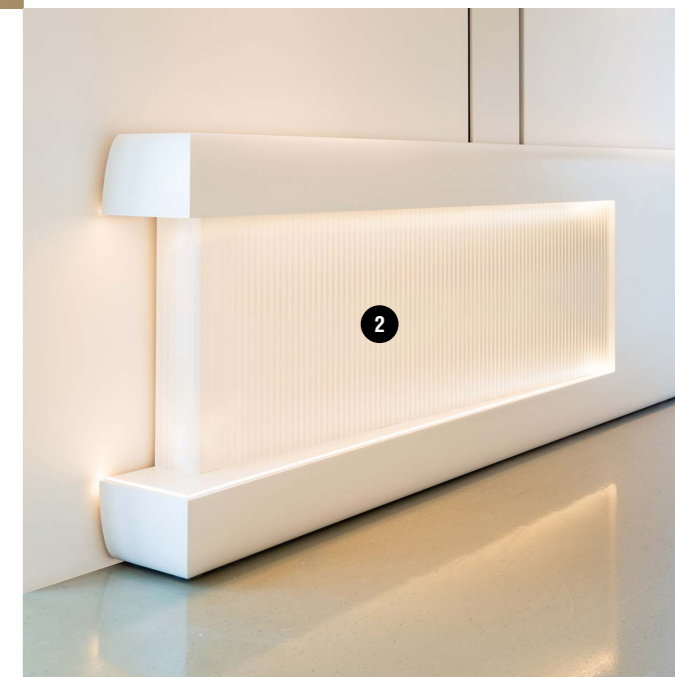



💡 Stately cornice mouldings are the perfect finish for your space.



1. C382 L3 | 2. C380 L3 | 3. C381 L3

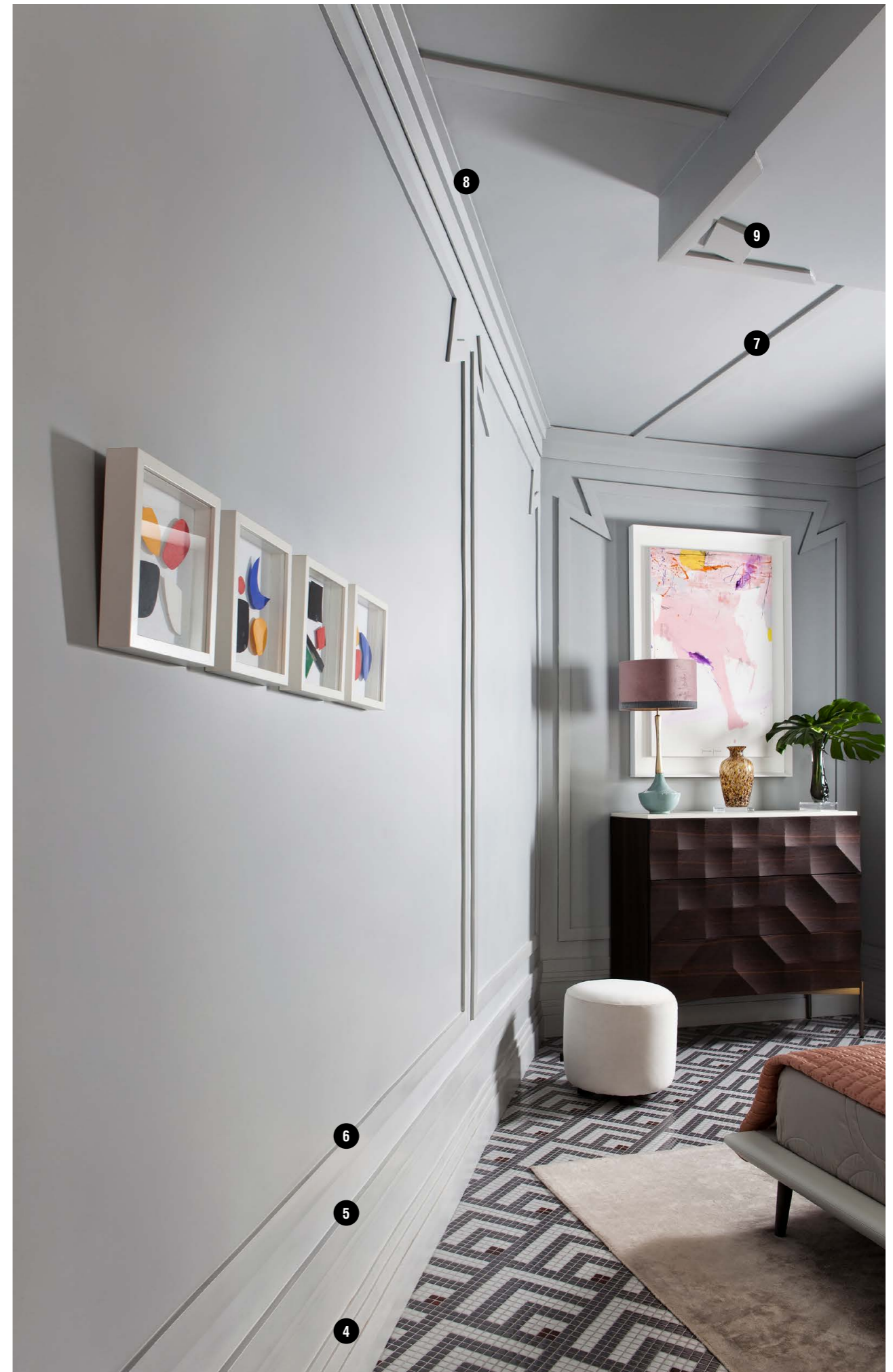

4. SX181 High Line | 5. SX180 High Line | 6. SX157 Square | 7. SX163 Square | 8. C391 Steps | 9. W100 Rombus



TRADITIONAL

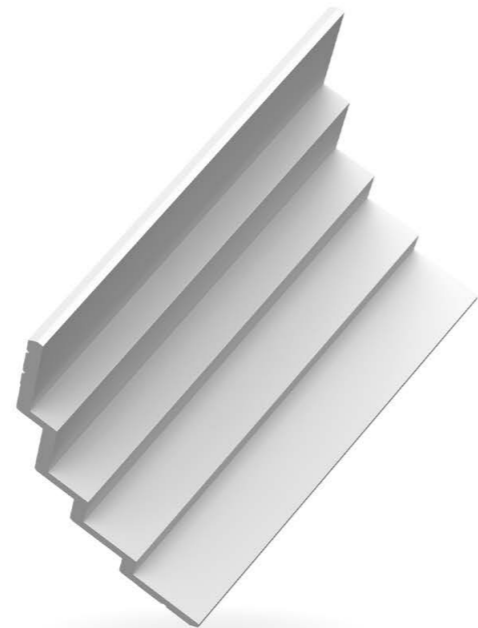

MODERN

The end of traditional boundaries

Boundaries fade when creativity takes charge. Whatever history lies behind a set of lines: smart employment of shapes and spaces can transform traditional lines into progressive profiles. And the other way around. Where does traditional end and modern begin? The relationship between design, architecture and aesthetics is constantly evolving. With the right combination, modern feels right at home even in traditional surroundings. And vice versa. It's all about where you draw the line.

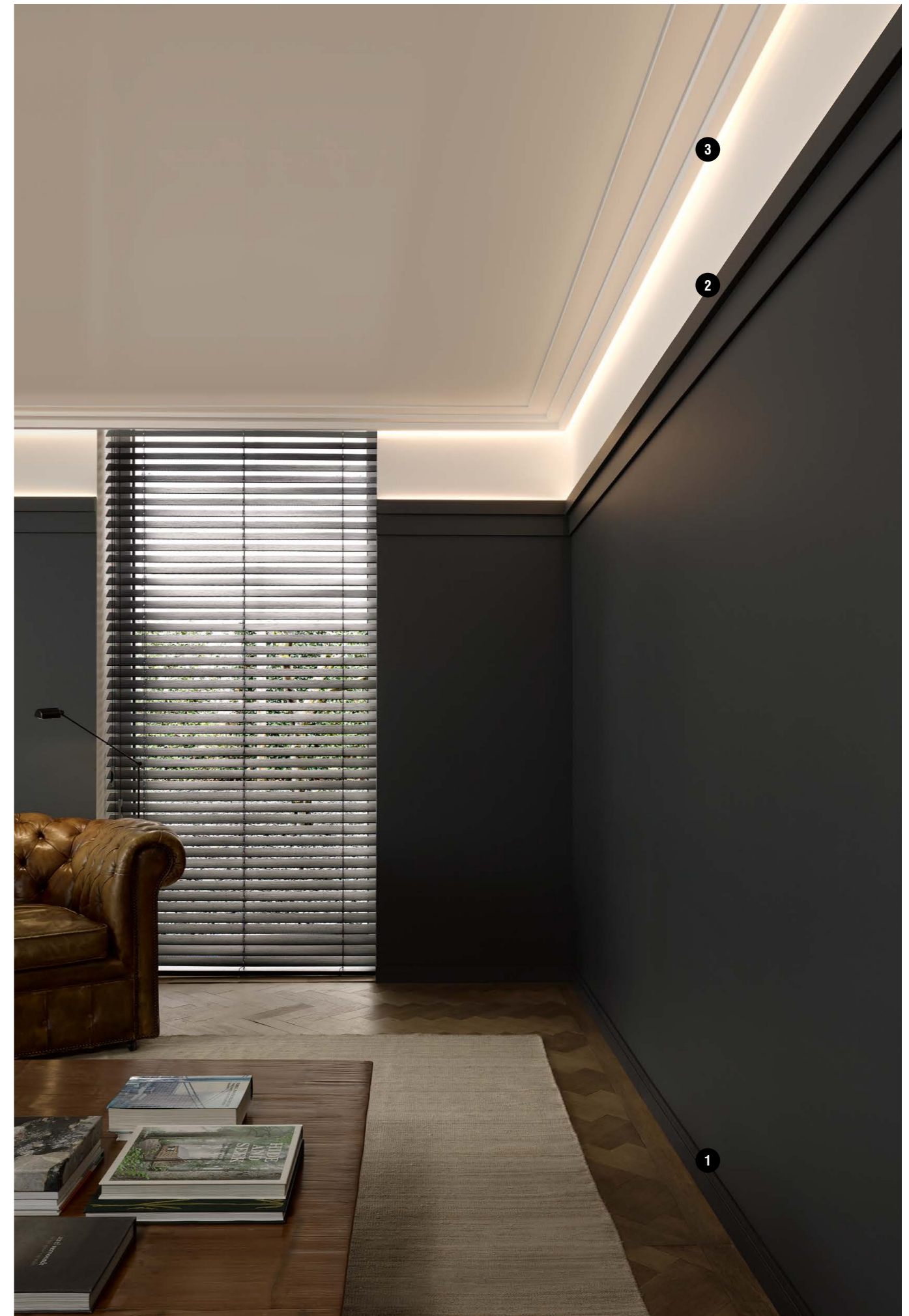

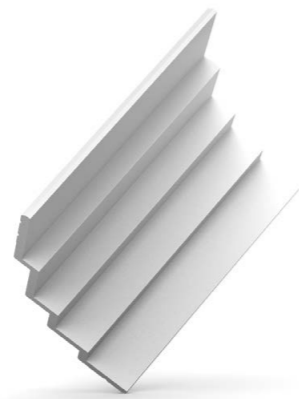

Cornice Mouldings

SPACIOUS EFFECT

A cornice moulding creates a visually attractive transition from wall to ceiling. Are you searching for a decorative or a functional solution? A wider or more heightened appearance for your space? We offer quality solutions for every budget. The profiles are easy to install, and some are available in flexible versions as well.



C360
200 x 2,1 x 6 cm
Purotouch®
Designed by Jacques Vergracht



C356
200 x 2 x 10 cm
Purotouch®
Designed by Jacques Vergracht



C353
200 x 3 x 16,5 cm
Purotouch®
Designed by Jacques Vergracht



C394 STEPS
200 x 3,1 x 9,5 cm
Purotouch®
Designed by Orio Tonini



C395 STEPS
200 x 3,1 x 15,5 cm
Purotouch®
Designed by Orio Tonini



C355
200 x 3,5 x 11,1 cm
Purotouch®
Designed by Jacques Vergracht



C354
200 x 4 x 21,5 cm
Purotouch®
Designed by Jacques Vergracht



C602 | C602F
200 x 5,3 x 5 cm
Purotouch®



C390 STEPS
200 x 6 x 10 cm
Purotouch®
Designed by Orio Tonini



C400
200 x 6 x 10 cm
Purotouch®



C391 STEPS
200 x 6 x 16 cm
Purotouch®
Designed by Orio Tonini



C396 STEPS
200 x 6,1 x 18,5 cm
Purotouch®
Designed by Orio Tonini



C991
200 x 11 x 14 cm
Purotouch®
Designed by Ulf Moritz



C991 + P9900
200 x 12 x 20 cm
Purotouch®



C991 + 2x P9900
200 x 18 x 21 cm
Purotouch®



C991
200 x 14 x 11 cm
Purotouch®
Designed by Ulf Moritz



C991 + P9900
200 x 20 x 12 cm
Purotouch®



C991 + 2x P9900
200 x 21 x 18 cm
Purotouch®



C394 STEPS
200 x 9,5 x 3,1 cm
Purotouch®
Designed by Orio Tonini

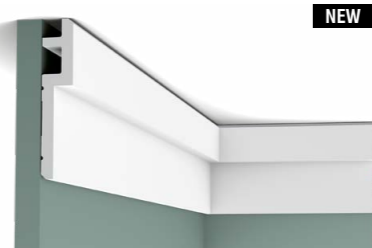

C395 STEPS
200 x 15,5 x 3,1 cm
Purotouch®
Designed by Orio Tonini



C393 STEPS
200 x 15 x 21 cm
Purotouch®
Designed by Orio Tonini

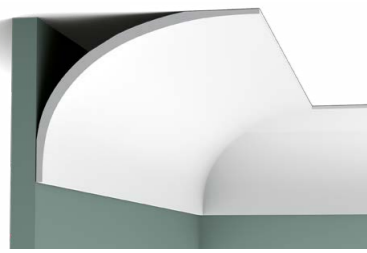

C990 INFINITY
200 x 15,9 x 21,6 cm
Purotouch®
Designed by Xavier Donck

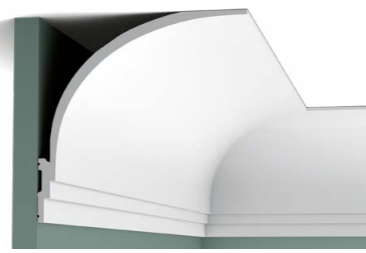

C990 + P9900
200 x 21,9 x 22,6 cm
Purotouch®

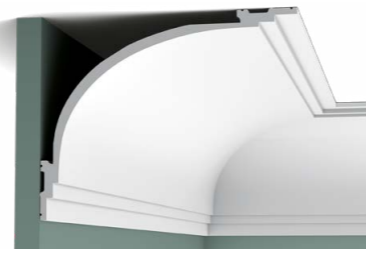
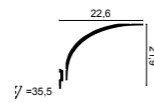

C990 + 2x P9900
200 x 22,9 x 28,6 cm
Purotouch®

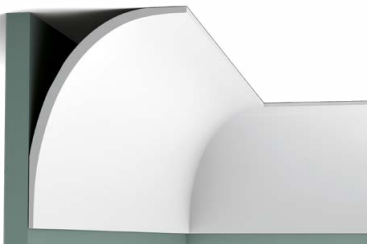
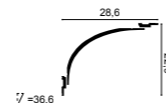

C990 INFINITY
200 x 15,9 x 21,6 cm
Purotouch®
Designed by Xavier Donck

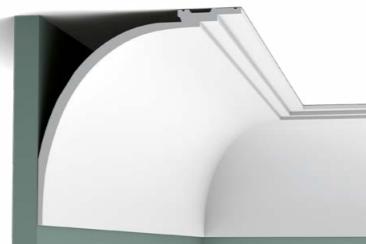
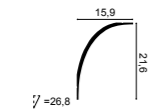

C990 + P9900
200 x 22,6 x 21,9 cm
Purotouch®

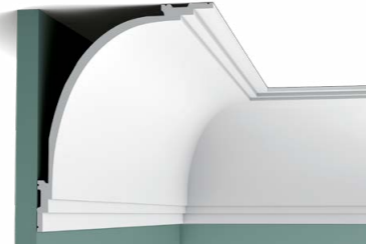
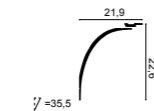

C990 + 2x P9900
200 x 28,6 x 22,9 cm
Purotouch®

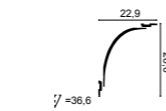

C391 STEPS
200 x 16 x 6 cm
Purotouch®
Designed by Orio Tonini

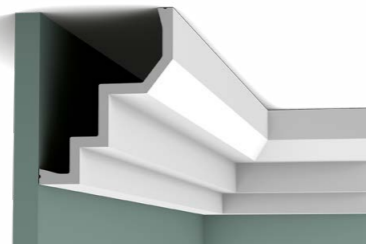
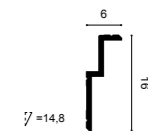

C300
200 x 16,5 x 13 cm
Purotouch®

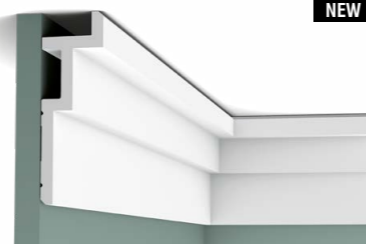
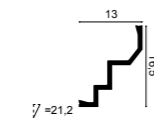

NEW

C396 STEPS
200 x 18,5 x 6,1 cm
Purotouch®
Designed by Orio Tonini

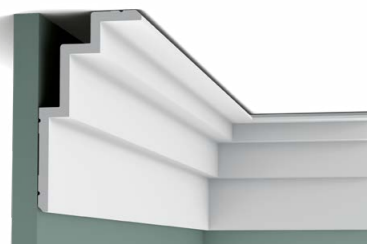
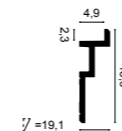

C392 STEPS
200 x 19 x 10 cm
Purotouch®
Designed by Orio Tonini

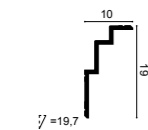

SX162 | SX162F SQUARE
200 x 1 x 4 cm
Duropolymer®

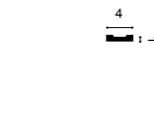

NEW

SX187 | SX187F HIGH LINE
200 x 1,2 x 7,5 cm
Duropolymer®
Designed by Pierre Daems

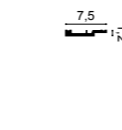

CX160
200 x 1,3 x 3,9 cm
Duropolymer®



SX157 | SX157F SQUARE
200 x 1,3 x 6,6 cm
Duropolymer®

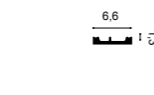

CX161
200 x 1,3 x 6,9 cm
Duropolymer®

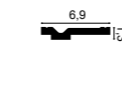

SX163 | SX163F SQUARE
200 x 1,3 x 10,2 cm
Duropolymer®

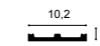

SX180 | SX180F HIGH LINE
200 x 1,6 x 12 cm
Duropolymer®
Designed by Pierre Daems

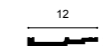

SX181 HIGH LINE
200 x 2,2 x 20 cm
Duropolymer®
Designed by Pierre Daems



CX126
200 x 8,7 x 8,7 cm
Duropolymer®

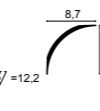

CURTAIN PROFILES



NEW

C394 STEPS
200 x 3,1 x 9,5 cm
Purotouch®
Designed by Orio Tonini

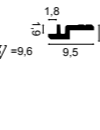

NEW

C395 STEPS
200 x 3,1 x 15,5 cm
Purotouch®

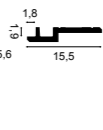

C390 STEPS
200 x 6 x 10 cm
Purotouch®
Designed by Orio Tonini

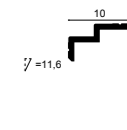

C391 STEPS
200 x 6 x 16 cm
Purotouch®
Designed by Orio Tonini

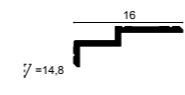

NEW

C396 STEPS
200 x 6,1 x 18,5 cm
Purotouch®
Designed by Orio Tonini

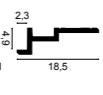

C991 STEPS
200 x 11 x 14 cm
Purotouch®
Designed by Ulf Moritz

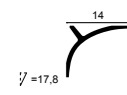

Steps

VERSATILE ABOVE ALL

This cleanly designed range contains seven profiles and is based on the main shape element of the C393. Steps lets you create a spacious effect. The mouldings are suitable for many applications: as a cornice moulding, border, curtain edging or as an up- or downlight. The various shapes can also be combined. Unify your entire space with this versatile range.

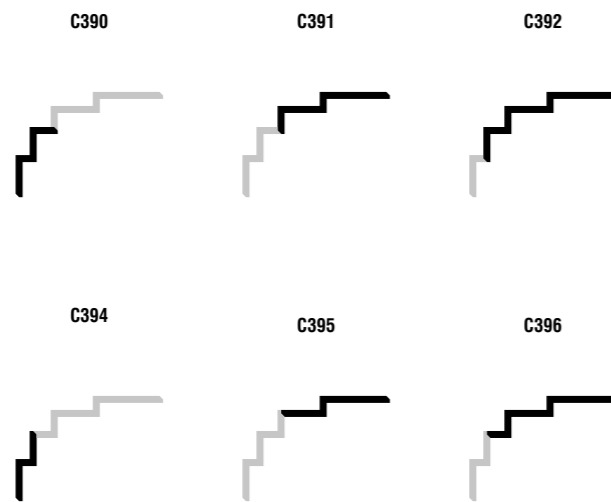
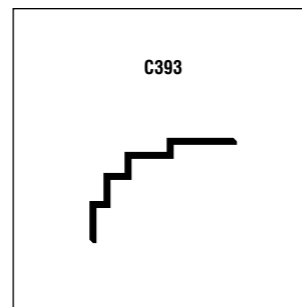

CORNICE MOULDINGS

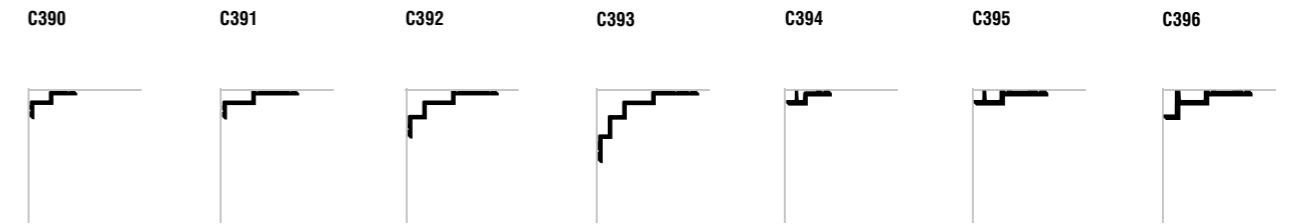

BORDER



CURTAIN PROFILES

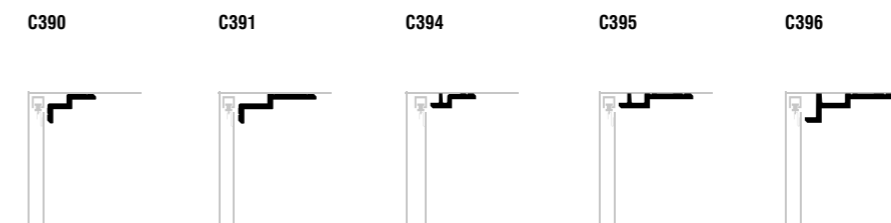

INDIRECT LIGHTING

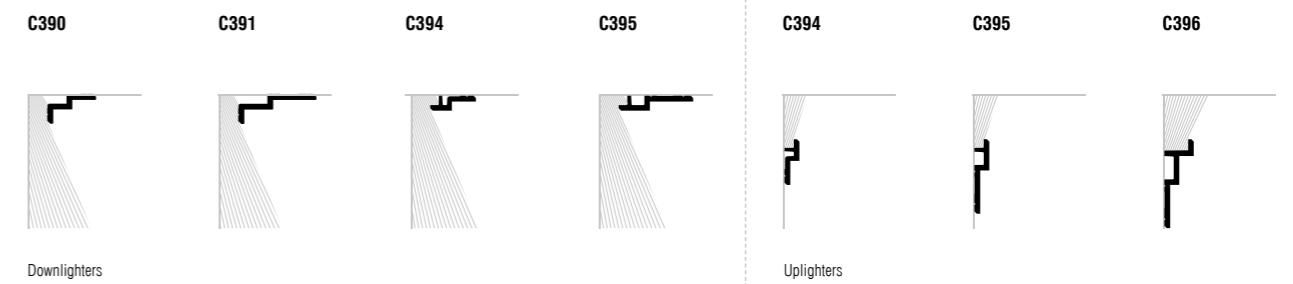



Wall Panels

CREATE A SENSE OF DEPTH

Making a flat wall come to life: we call this wallscaping. With our extensive range of panel mouldings, you can create graphic designs on your walls or ceilings in a jiffy. Moreover, they are easy to install and often available in flexible versions.

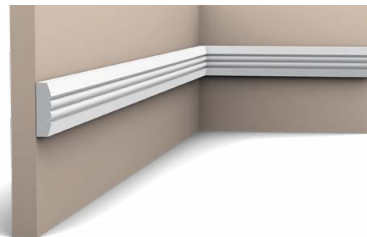

P5021 | P5021F
200 x 3,1 x 0,9 cm
Purotouch®

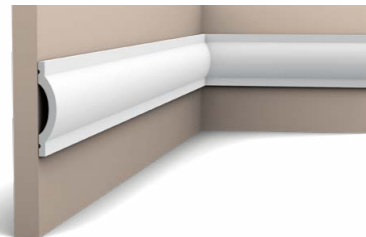

P9901 | P9901F
200 x 7 x 1,4 cm
Purotouch®

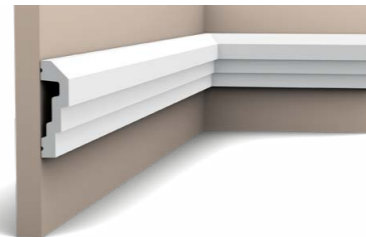

P7070 | P7070F
200 x 7,4 x 2,2 cm
Purotouch®

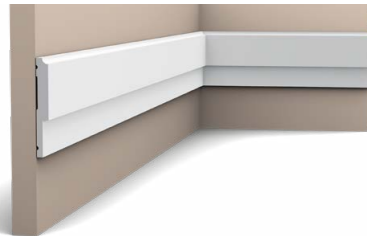

P9900 | P9900F
200 x 8 x 1 cm
Purotouch®

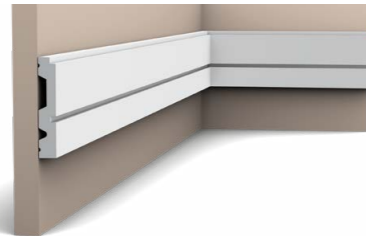

P5051
200 x 8,4 x 1,5 cm
Purotouch®
Designed by Jacques Vergracht

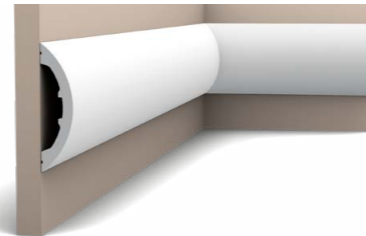

P3070 RADIUS
200 x 12,5 x 3,2 cm
Purotouch®
Designed by Ulf Moritz



P5050
200 x 20 x 1,5 cm
Purotouch®
Designed by Jacques Vergracht

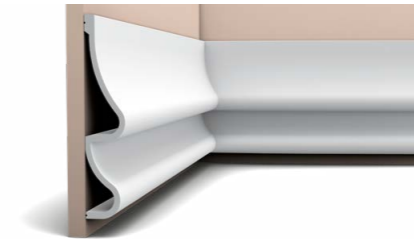

P3071 GOLF
200 x 37,2 x 7,6 cm
Purotouch®
Designed by Ulf Moritz

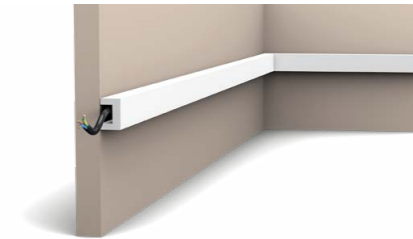

CX190 | CX190F U-PROFILE
200 x 3 x 2 cm
Duropolymer®
Designed by Orio Tonini

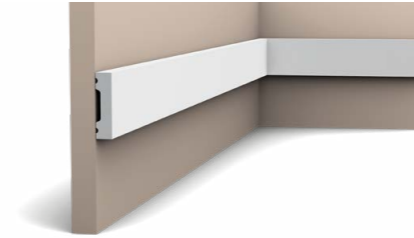

SX162 | SX162F SQUARE
200 x 4 x 1 cm
Duropolymer®

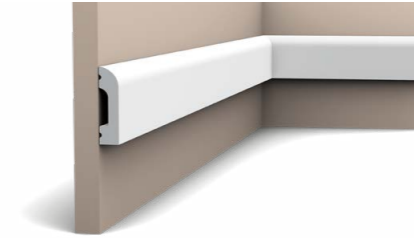

SX182 | SX182F CASCADE
200 x 5 x 1,3 cm
Duropolymer®

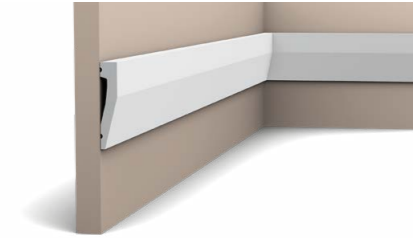

SX159
200 x 6 x 1,2 cm
Duropolymer®

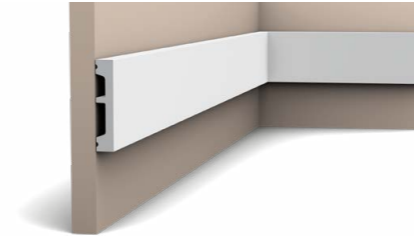

SX157 | SX157F SQUARE
200 x 6,6 x 1,3 cm
Duropolymer®

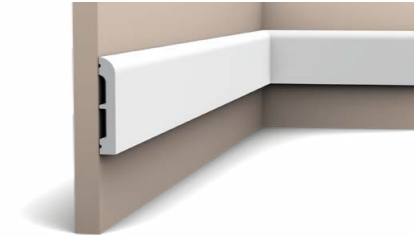

SX183 | SX183F CASCADE
200 x 7,5 x 1,3 cm
Duropolymer®

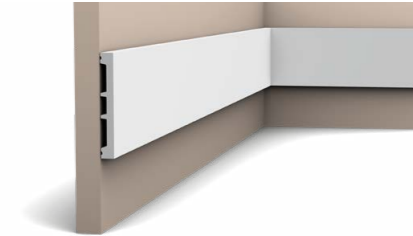

SX163 | SX163F SQUARE
200 x 10,2 x 1,3 cm
Duropolymer®

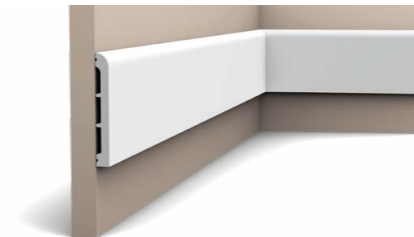

SX184 | SX184F CASCADE
200 x 11 x 1,3 cm
Duropolymer®

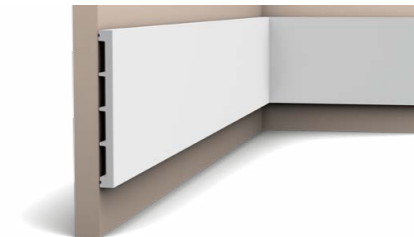

SX168 SQUARE
200 x 15,1 x 1,4 cm
Duropolymer®



Skirting

THE PERFECT FINISH FOR FLOORS

All skirting boards are made from Duropolymer®, an impact- and water-resistant polymer mix that is fully recyclable. Cables can be hidden easily, and the flexible versions allow curved walls to be finished elegantly. The skirting boards are pre-primed for easy painting.

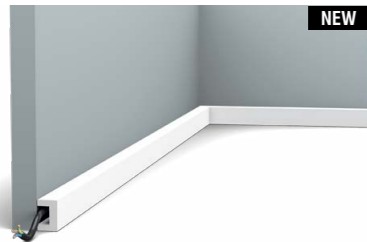

CX190 | CX190F U-PROFILE
200 x 3 x 2 cm
Duropolymer®
Designed by Orio Tonini

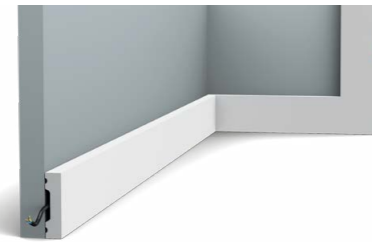

SX162 | SX162F SQUARE
200 x 4 x 1 cm
Duropolymer®

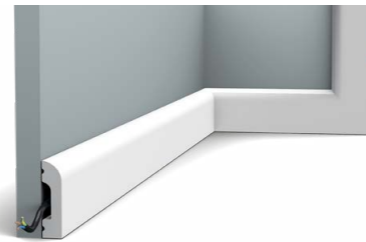

SX182 | SX182F CASCADE
200 x 5 x 1,3 cm
Duropolymer®

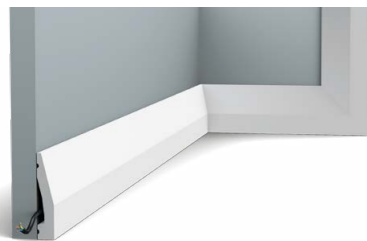

SX159
200 x 6 x 1,2 cm
Duropolymer®

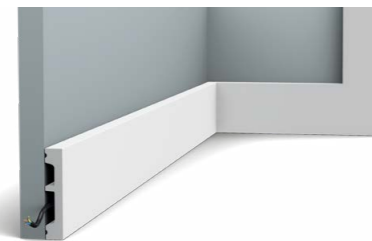

SX157 | SX157F SQUARE
200 x 6,6 x 1,3 cm
Duropolymer®

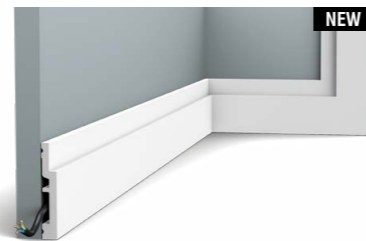

SX187 | SX187F HIGH LINE
200 x 7,5 x 1,2 cm
Duropolymer®
Designed by Pierre Daems



SX183 | SX183F CASCADE
200 x 7,5 x 1,3 cm
Duropolymer®



SX179 | SX179F DIAGONAL
200 x 9,7 x 2,9 cm
Duropolymer®
Designed by Orio Tonini



SX171 SQUARE
200 x 10 x 2,2 cm
Duropolymer®

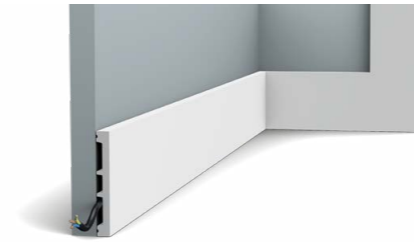

SX163 | SX163F SQUARE
200 x 10,2 x 1,3 cm
Duropolymer®



SX105 | SX105F
200 x 10,8 x 1,3 cm
Duropolymer®



SX155 | SX155F
200 x 10,8 x 2,5 cm
Duropolymer®



SX184 | SX184F CASCADE
200 x 11 x 1,3 cm
Duropolymer®



SX180 | SX180F HIGH LINE
200 x 12 x 1,6 cm
Duropolymer®
Designed by Pierre Daems



SX185 CASCADE
200 x 12 x 2,5 cm
Duropolymer®

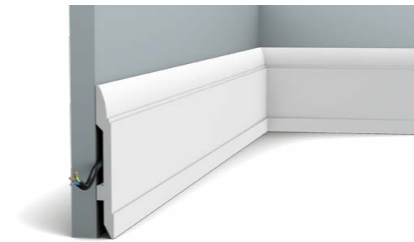

SX104 | SX104F
200 x 14,8 x 1,7 cm
Duropolymer®

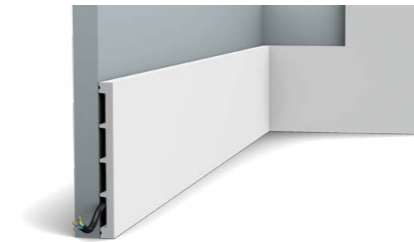

SX168 SQUARE
200 x 15,1 x 1,4 cm
Duropolymer®



SX181 HIGH LINE
200 x 20 x 2,2 cm
Duropolymer®
Designed by Pierre Daems



Indirect Lighting

LEDS SET THE MOOD

Indirect lighting is great as mood lighting and to create a more spacious feeling. Whether tautly linear or organic, direct or indirect, one thing is certain: the lighting enhances architecture. What's more, the compact LED lighting ensures an energy-efficient and durable solution and is guaranteed for life.



C380 L3
200 x 5 x 5 cm
Purotouch®
Designed by Orio Tonini

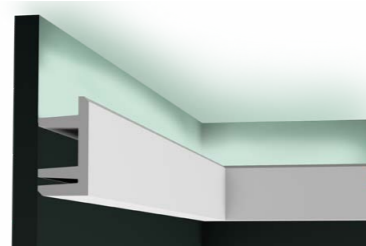
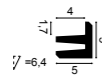

C381 L3
200 x 9,5 x 5 cm
Purotouch®
Designed by Orio Tonini

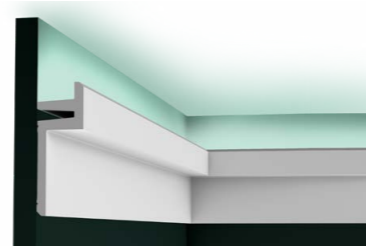
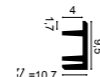

C382 L3
200 x 14 x 5 cm
Purotouch®
Designed by Orio Tonini

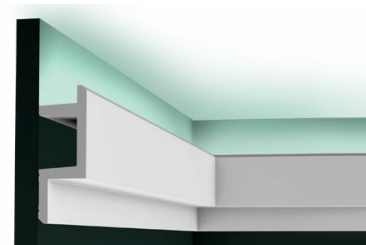

C383 L3
200 x 14 x 5 cm
Purotouch®
Designed by Orio Tonini

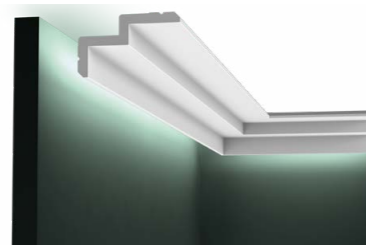
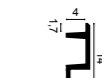

C390 STEPS
200 x 6 x 10 cm
Purotouch®
Designed by Orio Tonini

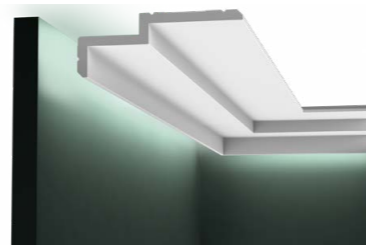
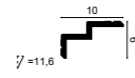

C391 STEPS
200 x 6 x 16 cm
Purotouch®
Designed by Orio Tonini

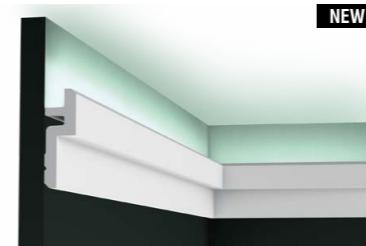

C394 STEPS
200 x 9,5 x 3,1 cm
Purotouch®
Designed by Orio Tonini



C395 STEPS
200 x 15,5 x 3,1 cm
Purotouch®
Designed by Orio Tonini

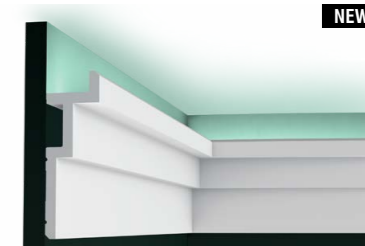

C396 STEPS
200 x 18,5 x 6,1 cm
Purotouch®
Designed by Orio Tonini

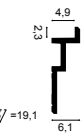

C361 STRIPE
200 x 5 x 5 cm
Purotouch®
Designed by Pierre Daems

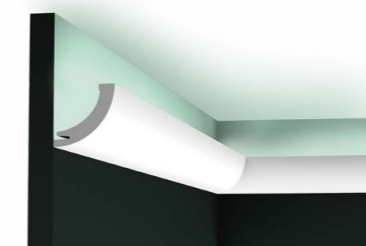

C362 CURVE
200 x 5 x 5 cm
Purotouch®
Designed by Pierre Daems

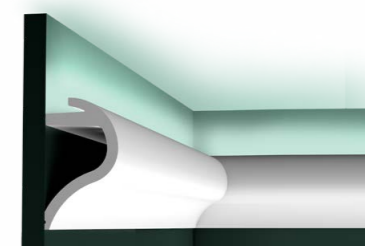

C364 WAVE
200 x 14 x 8 cm
Purotouch®
Designed by Pierre Daems

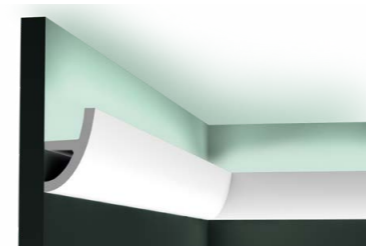
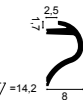

C373 | C373F ANTONIO
200 x 8 x 5 cm
Purotouch®
Designed by Ulf Moritz

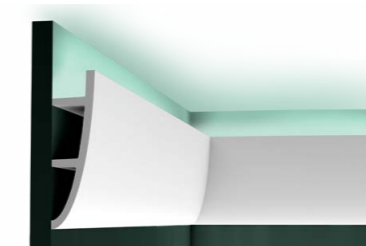

C374 | C374F ANTONIO
200 x 18 x 5 cm
Purotouch®
Designed by Ulf Moritz

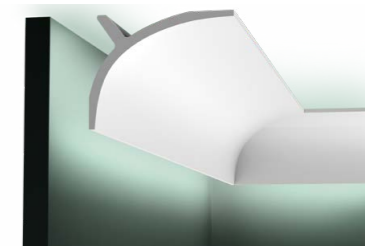

C991
200 x 11 x 14 cm
Purotouch®
Designed by Ulf Moritz

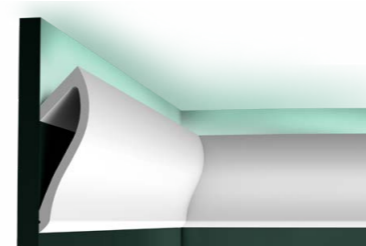

C371 SHADE
200 x 18,5 x 5,8 cm
Purotouch®
Designed by Ulf Moritz

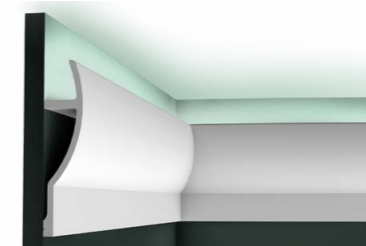
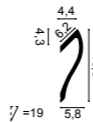

C372 FLUXUS
200 x 28 x 7 cm
Purotouch®
Designed by Ulf Moritz

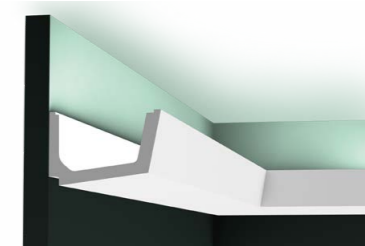
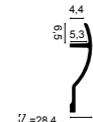

C357 STRAIGHT
200 x 7,1 x 11 cm
Purotouch®
Designed by Jacques Vergracht

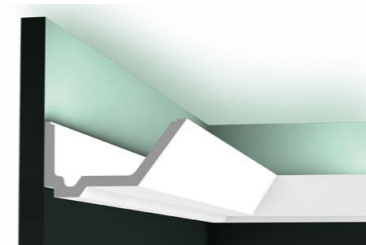

C358 RAIL
200 x 7,3 x 14 cm
Purotouch®
Designed by Jacques Vergracht

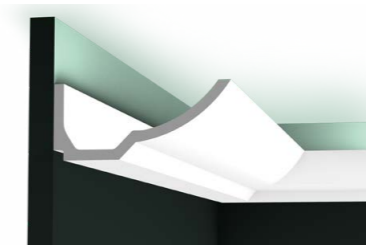

C351 BOAT
200 x 7,4 x 17,3 cm
Purotouch®
Designed by Jacques Vergracht

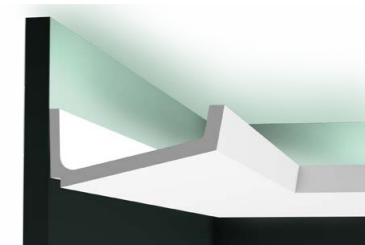

C352 FLAT
200 x 7,6 x 17 cm
Purotouch®
Designed by Jacques Vergracht





CX190 | CX190F U-PROFILE

200 x 2 x 3 cm
Duropolymer®
Designed by Orio Tonini

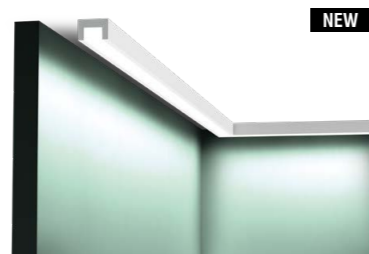

CX190 | CX190F U-PROFILE

200 x 2 x 3 cm
Duropolymer®
Designed by Orio Tonini

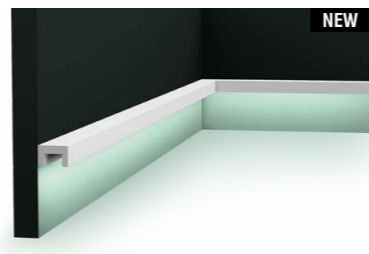

CX190 | CX190F U-PROFILE

200 x 2 x 3 cm
Duropolymer®
Designed by Orio Tonini



CX189 | CX189F

200 x 2,7 x 2,7 cm
Duropolymer®
Designed by Orio Tonini

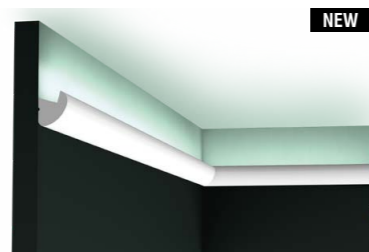

CX188 | CX188F

200 x 3,4 x 3 cm
Duropolymer®
Designed by Orio Tonini

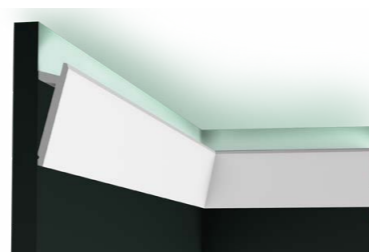

**SX179 | SX179F
DIAGONAL**

200 x 9,7 x 2,9 cm
Duropolymer®
Designed by Orio Tonini

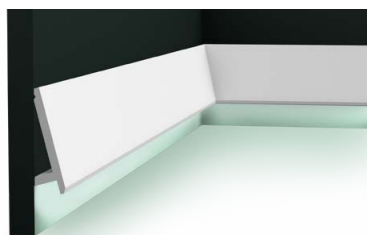
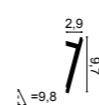

**SX179 | SX179F
DIAGONAL**

200 x 9,7 x 2,9 cm
Duropolymer®
Designed by Orio Tonini

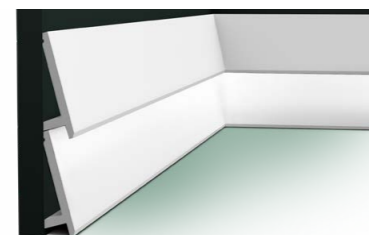
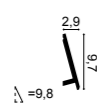

**2x SX179 | SX179F
DIAGONAL**



25 profiles in a row

Indirect lighting that can be used to set a mood, create a spacious effect or as a true eye-catcher. These elegant fixtures are lightweight, easy to install and impact-resistant. They are also compatible with standard LED profiles. Paint them to match the wall or add a colour accent. The possibilities are endless.



COMPACT DESIGN LIGHTING

- Lightweight and impact-resistant
- Budget friendly
- Easy LED integration when combined with aluminium profile or strip
- In addition to functioning as profiles for indirect lighting, some of these are also suitable for use in other applications. As skirting boards (SX179, SX190), but also for wall panelling, cornice mouldings or even as direct lighting (SX190)!

Organic

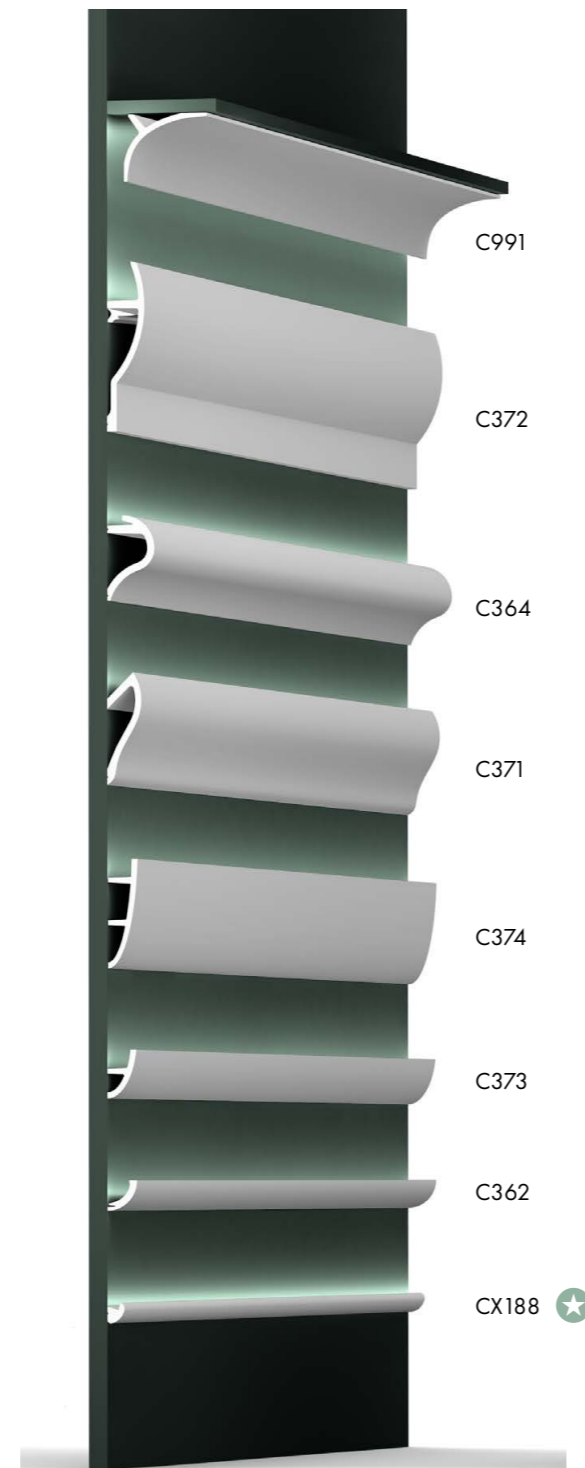

Linear

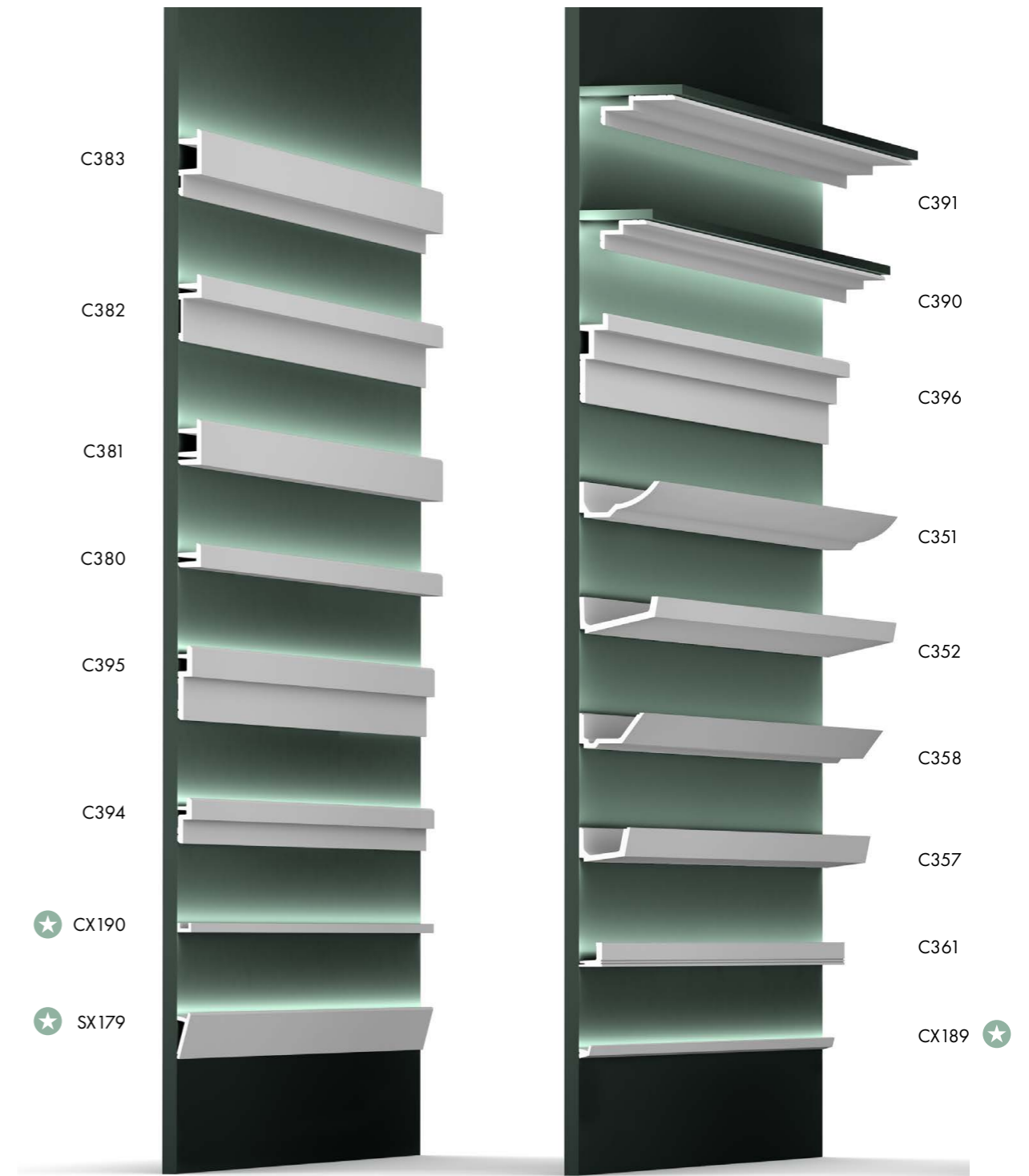

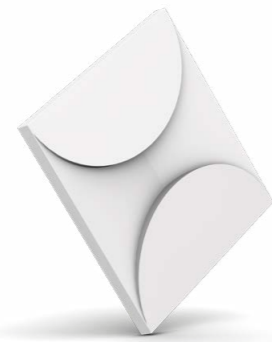

Decorative Elements

AN ARTY TOUCH

Transform bare walls into eye-catching façades in no time. Follow your imagination. Restrained, clean lines or a true eyecatcher? The unlimited potential of this 3D panelling makes every room unique.



W100 ROMBUS
25,8 x 15 x 2,9 cm
Purotouch®



W105 ROMBUS
30 x 34,6 x 3 cm
Purotouch®

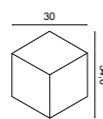

W101 TRAPEZIUM
34,5 x 15 x 2,9 cm
Purotouch®

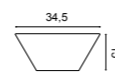

W102 CUBI
33,3 x 33,3 x 2,5 cm
Purotouch®

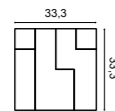

W103 CUBI
33,3 x 33,3 x 2,5 cm
Purotouch®

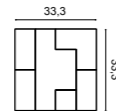

W104 KILT
45 x 45 x 3,6 cm
Purotouch®
Designed by Orio Tonini

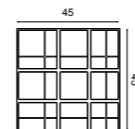

NEW

W106 ENVELOP
33,3 x 33,3 x 2,9 cm
Purotouch®
Designed by Orio Tonini

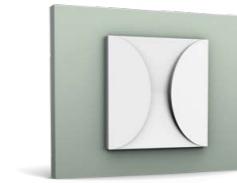
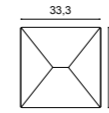

NEW

W107 CIRCLE
33,3 x 33,3 x 2,9 cm
Purotouch®
Designed by Orio Tonini

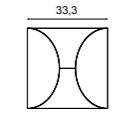

NEW

W108 ZIGZAG
200 x 25 x 1,8 cm
Purotouch®
Designed by Orio Tonini

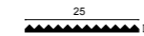

NEW

W108 ZIGZAG + 2x CX190

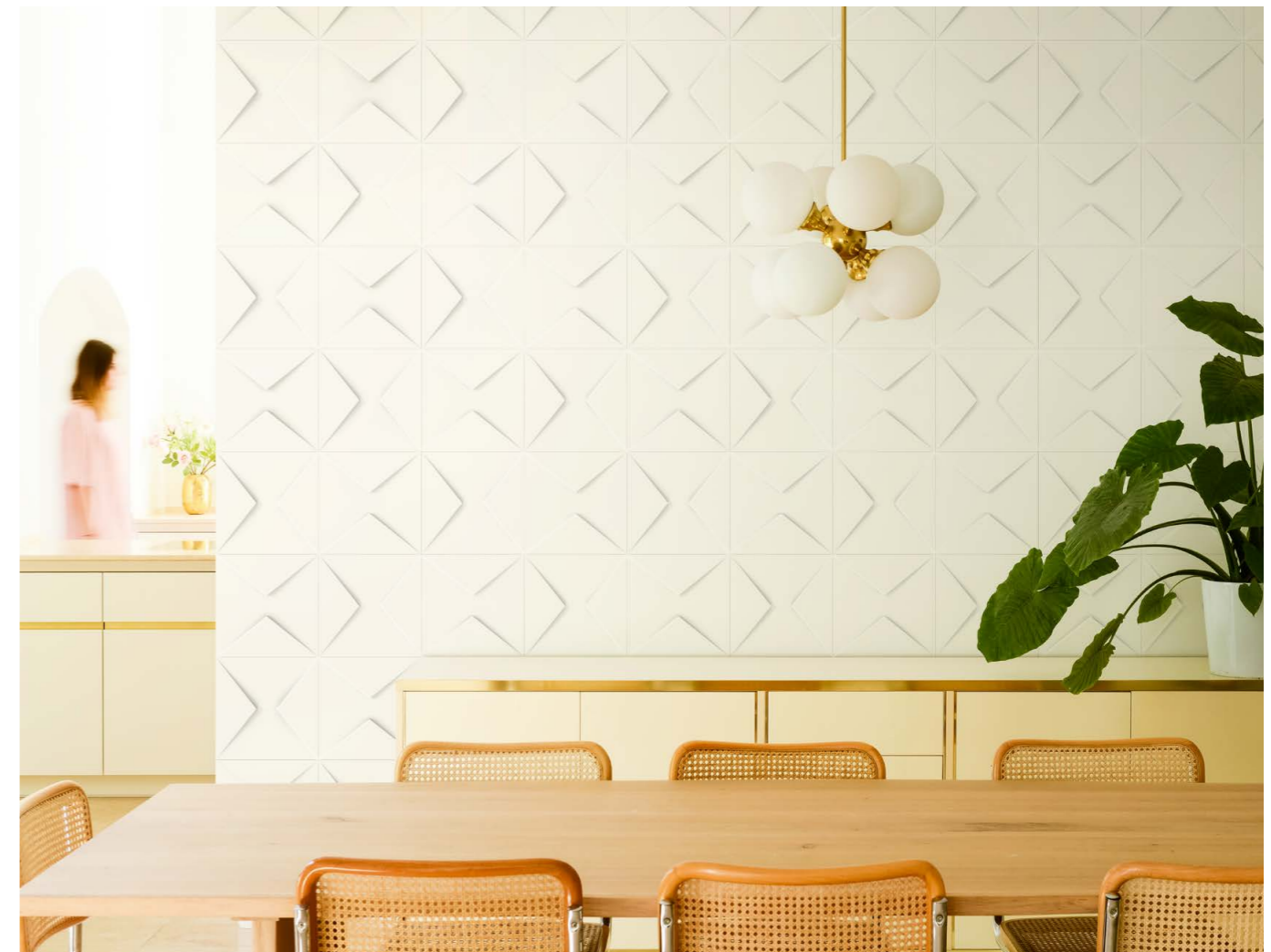

The Perfect Finish

INSTALLED IN A FLASH

Only full guarantee with DecoFix®

1 PREPARATION AND CONTROL

Atmosphere

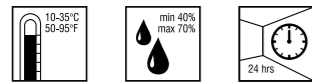

Storage and installation conditions
Store profiles and adhesives at room temperature and wait 24 hours before installing.

Surface

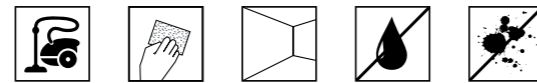

Dust free
Sand and wash surface
Flat wall & ceilings
Dry
No grease

2 USING THE RIGHT DECOFIX® GLUE

Interior

Porous and dry surface



OR

Exterior

Non-porous and humid surface



Seal wall/
ceiling



DecoFix Pro
Strong, water-based acrylic
installation adhesive

FDP500 310ml | 7 > 8m
FDP600 4200ml | 65 > 110m



DecoFix Hydro/Power
Very strong MS-Polymer-based
installation adhesive

FDP700 290ml | 7 > 8m



Joints
between
mouldings*



DecoFix Extra
Polyurethane-based adhesive

FX200 310ml | min. 80m
FX210 tube 80ml | min. 20m

*For Durofoam®: use DecoFix Pro for joints

3 INSTALLATION AND GUIDE



Installation videos & manuals
Decofix Glue Calculator

Scan the QR code or visit:
www.oracdecor.com > Installation

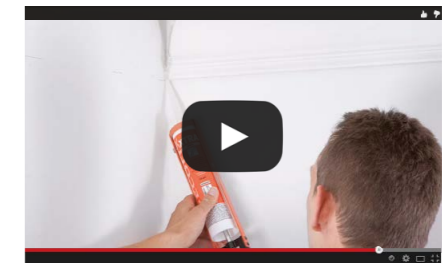

4 TOOLS AND ACCESSORIES



FDP100



FB15

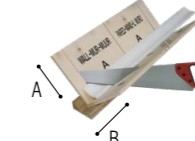

FB300
A: 29,7 cm
B: 29,1 cm



FB13
A: 12,5 cm
B: 15,5 cm

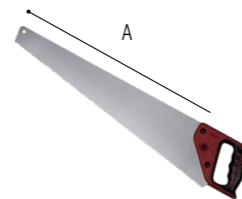

FB14
A: 60 cm



FB10
A: 27,5 cm
B: 22 cm



SPECIAL THANKS!

Rietveld Projects — www.rietveldprojects.be
Naudts Patrick (Belex)
HQ Samsonite — www.pinkeye.be (Design studio)
Manuel Espejo — www.manuelespejo.es
Raul Martins — www.raulmartins.com
Atelier DAAA — www.atelierdaaa.com (Photographer: Bertrand Fompeyrine)

Marisa, Anastasia, Zariza Art, Maister, Orio, Bjorn, Johan, Pascal, Benjamin,
Nico, Alexandra, Verne, Gazeuse, Zoomzone, Stefaan Temmerman,
Brian Hallett, Nacho Uribesalazar, CASA DECOR Madrid

All rights reserved. ©2018, ORAC nv

Guarantee terms and conditions apply if provided installation instructions have been followed to the letter. Fire retardant standards. In many interiors and projects strict fire regulations are imposed. Therefore, ORAC has implemented a number of solutions depending on the country and its regulations. Please contact us for more information.

The information in this catalogue is without engagement. Changes and discrepancies in sizes or/and shapes against those stated in the catalogue can occur. This catalogue and the design embodied within are protected by copyright law and international treaties. Unauthorized reproduction of the catalogue, any portion of it or the reproduction of the designs embodied therein may result in severe civil and criminal penalties and will be prosecuted to the maximum. Further legal information can be found on: www.oracdecor.com.

ORAC
D E C O R

Registered ctm
design N°

C351/000257464-0003	C382/003242569-0003	P3070/2088880-0004	W105/004097780-0001
C352/000257464-0004	C383/003242569-0004	P3071/2088880-0005	C394/005329026-001
C353/000257464-0005	C390/003242569-0005	P5050/000257464-0001	C395/005329026-002
C354/000257464-0006	C391/003242569-0006	P5051/000257464-0002	C396/005329026-003
C355/000257464-0007	C392/003242569-0007	P9900/000995576-0004	CX188/005329026-004
C356/000257464-0008	C393/003242569-0008	SX168/002341727-0004	CX189/005329026-005
C361/1890526-0001	C990/000995576-0002	SX171/002920140-0001	CX190/005329026-006
C362/1890526-0002	C991/002524769-0007	SX179/003242569-0015	SX187/005329026-007
C364/1890526-0004	G70/002158089-0001	SX180/003242569-0016	W106/005329026-008
C371/2088880-0002	G71/002158089-0002	SX181/003242569-0017	W107/005329026-009
C372/2088880-0003	G72/002158089-0003	W100/003356278-0001	W108/005329026-010
C373/002524769-0005	G75/002524769-0009	W101/003356278-0002	SX182/004097780-0002
C374/002524769-0006	G76/002524769-0010	W102/003356278-0003	SX183/004097780-0003
C380/003242569-0001	G77/002524769-0011	W103/003356278-0004	SX184/004097780-0004
C381/003242569-0002	G78/002524769-0012	W104/003356278-0005	SX185/004097780-0005

EN - MP042-002 (SOFTCOVER) / MP042-102 (HARDCOVER)

concept & layout by maister.be

ORAC HEADQUARTERS
NV ORAC SA
Biekorfstraat 32
8400 Ostend, BELGIUM
T +32 (0)59 80 32 52
info@oracdecor.com

ORAC NEDERLAND
T 0800-022 2125
nederland@oracdecor.com

ORAC FRANCE
T 0800-900 358
france@oracdecor.com

ORAC DEUTSCHLAND
T 0800-181 3694
deutschland@oracdecor.com

ORAC (UK) LTD
City Business Centre
Brighton Road, Unit 8
Horsham RH13 5BB - UK
T +44 1403 240 102
uk@oracdecor.com

ORAC SLOVAKIA S.R.O.
Kpt. Nalepku 6
08271 Lipany - SK
T +421 (0)514-891 581
slovakia@oracdecor.com

ORAC SPAIN
C/ Roger de Llúria 67-69 Pral 2º
08009 Barcelona - ESPAÑA
T 900 99 32 89
spain@oracdecor.com

ORAC RUSSIA
249020, Россия, Калуж ская область
Боровский район,
инду стральный парк Ворсино
ООО «Орак»
info@oracdecor.ru

